

Analysis of Radar and Air-Visual UFO Observations on 24 October 1968 at Minot AFB, North Dakota, USA

Claude Poher, Ph.D.¹

August
2005

We are in the presence of an exceptional UFO case, observed by trained professionals and corroborated by sophisticated means. The general characteristics are typical of other UFO observations, which are validated by the study of numerous reports and the testimonials of thousands of eyewitnesses. I would like to thank my colleagues Thomas Tulien, James Klotz (USA), and Martin Shough (Scotland), who have accomplished a colossal job of historical recreation and collection of data. Without their tenacity and concern in checking the smallest details we would know very little about this extraordinary observation. Furthermore, thanks to all direct protagonists who agreed to speak and clarify their personal observations after more than thirty years. The USAF did not classify this observation, however, considering their responsibilities, these witnesses were naturally obliged to remain silent or jeopardize their professional careers. The end of the Cold War, and the fact that most are now retired has certainly contributed to the release of the information. Without their contributions we would not have been able to successfully complete this analysis. The manuscript was prepared from June to August 2005, and translated in November 2005, with additional editorial work by Thomas Tulien and Prof. Suzanne Jones. Amendments were made in February 2006, with two additional discussion sections added in March 2006.

Editor's note: The presentation of this study is organized into five parts, which include two discussion sections and three appendices. Part 1: Basic Information Concerning Minot AFB and the UFO Events. Part 2: Descriptions of the B-52 Radarscope Photographs. Part 3 is a 2-Dimensional Analysis of the Photos. Part 4 is a 3-Dimensional Analysis of the Photos, and Discussion 1: The B-52 Altitude and Tilt-up Angle of the Radar Antenna. Part 5 considers the possibility of an Ionized Cloud Surrounding the UFO and the physical effects, including Discussion 2: Photometric Study and the Ionized Cloud Surrounding the UFO. The appendices consist of App. 1: Timing of the B-52 Trajectory and a discussion of time discrepancies in the documentation; App. 2: Descriptive Measurements of the Photos; and App. 3: is a collection of Observer Accounts of the UFO Events from the documentation.

¹See Bio from: http://www.minotb52ufo.com/radar_analyses.php

Part 1. Basic Information Concerning Minot AFB and the UFO Events

1.1. Magnetic Orientation of the Runway at Minot AFB

When I received the following map from Tulien and Klotz, I noticed something peculiar regarding the trajectory of the B-52. In the Project Blue Book documentation the runway heading is referred to as 11 / 29, but should in fact be oriented 110 / 290 degrees from geographical north according to the rules of civil aviation.

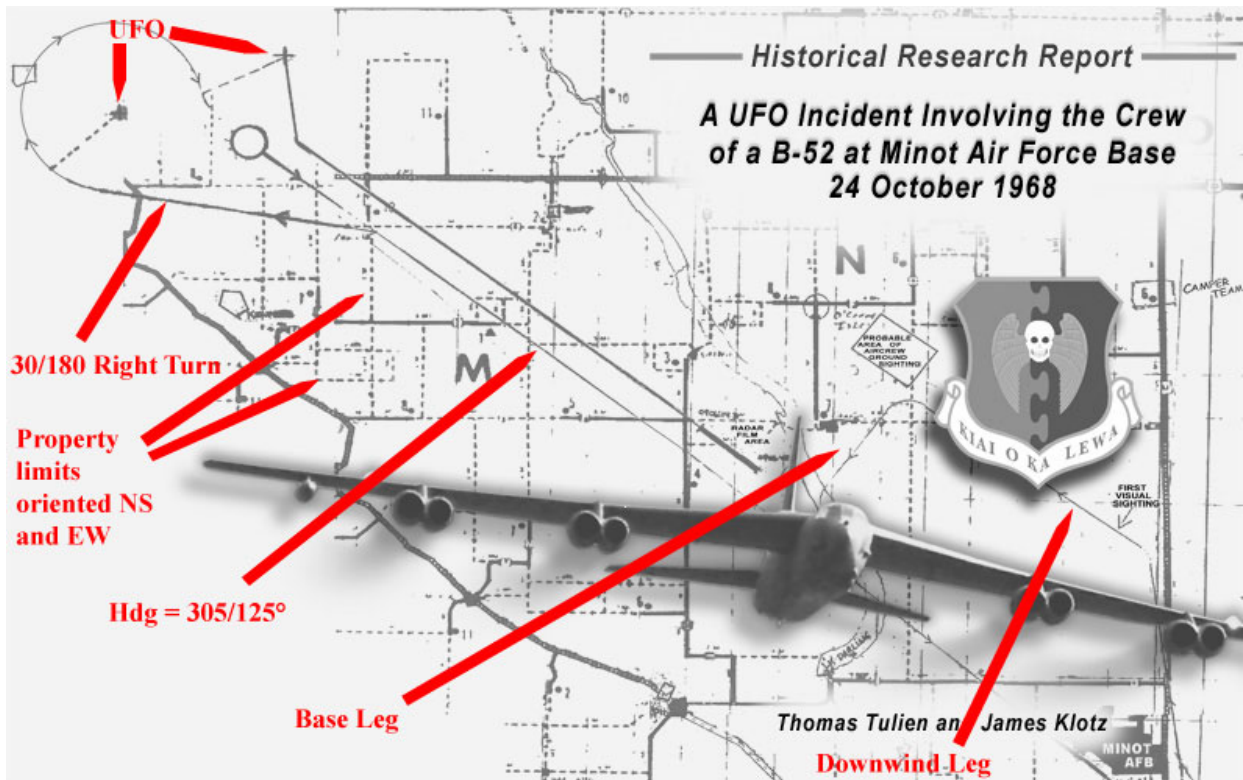
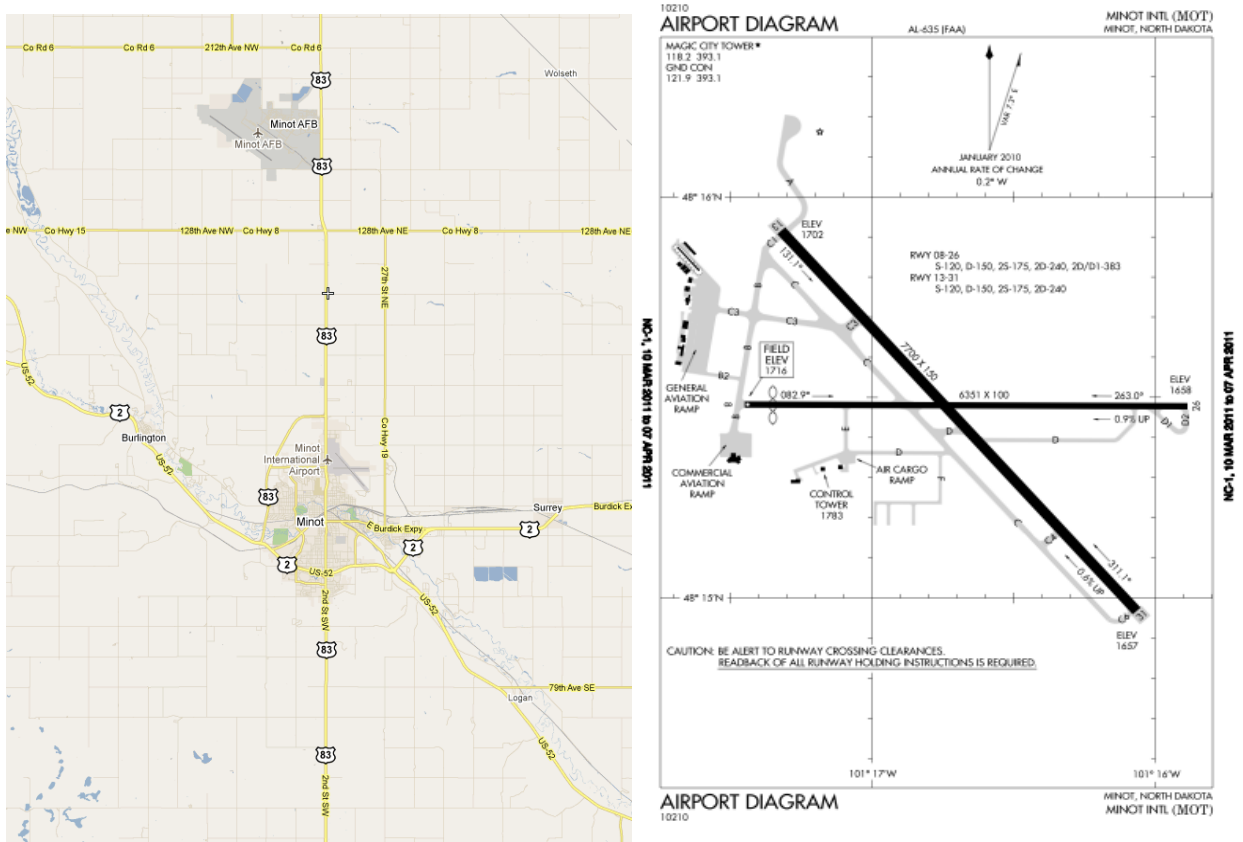

Figure 1. Enlarged map with indications added in red. In keeping with U.S. conventions, on this map the borders of the farm properties are denoted by dotted lines, commonly oriented north / south and east / west. We see the trajectory of the B-52 drawn with a standard 180° turn in the upper left corner of the map. However, on this map the trajectory of approach of the B-52 is oriented on true courses 125 / 305° and not on courses 110 / 290° as indicated in the documents. It seems that magnetic and true courses do not match one another.

In Figure 1, the trajectory and traffic patterns around the airport do not have this orientation because 290 degrees is almost directly west, whereas the map indicates a trajectory to

the northwest. For comparative purposes I located a map of the Minot international civilian airport. We see that the main runway 13/31 is oriented at true headings of 130 and 310 degrees, which conform to the trajectories in Figure 1. The second short civilian runway 08/26 is oriented at 080 /260 degrees true. Therefore, the prevailing winds in the region are oriented 130/310 degrees. An online search located the following regional map showing the position of Minot AFB in relation to the city of Minot, ND.



Figures 2 and 3. Location of Minot Air Force Base (KMIB) thirteen miles north of Minot, N.D; and diagram of Minot international airport (KMOT).²

Based on the scale of the map, Minot AFB is located 13 miles (21 km) north of the city of Minot, ND. Even though it is unlikely that prevailing winds are different between the two

² Map sources: <http://wikimapia.org/#lat=48.3208755&lon=-101.2939453&z=12&l=0&m=h>; and <http://skyvector.com/airport/MOT/Minot-International-Airport>.

airports, I nevertheless checked wind conditions. Another online search was more difficult, likely because Minot AFB is still a strategic airbase with nuclear missiles on alert. On a web site devoted to civilian pilots I located a simplified air view of the base, in which the runway is clear and the confidential installations are not indicated.

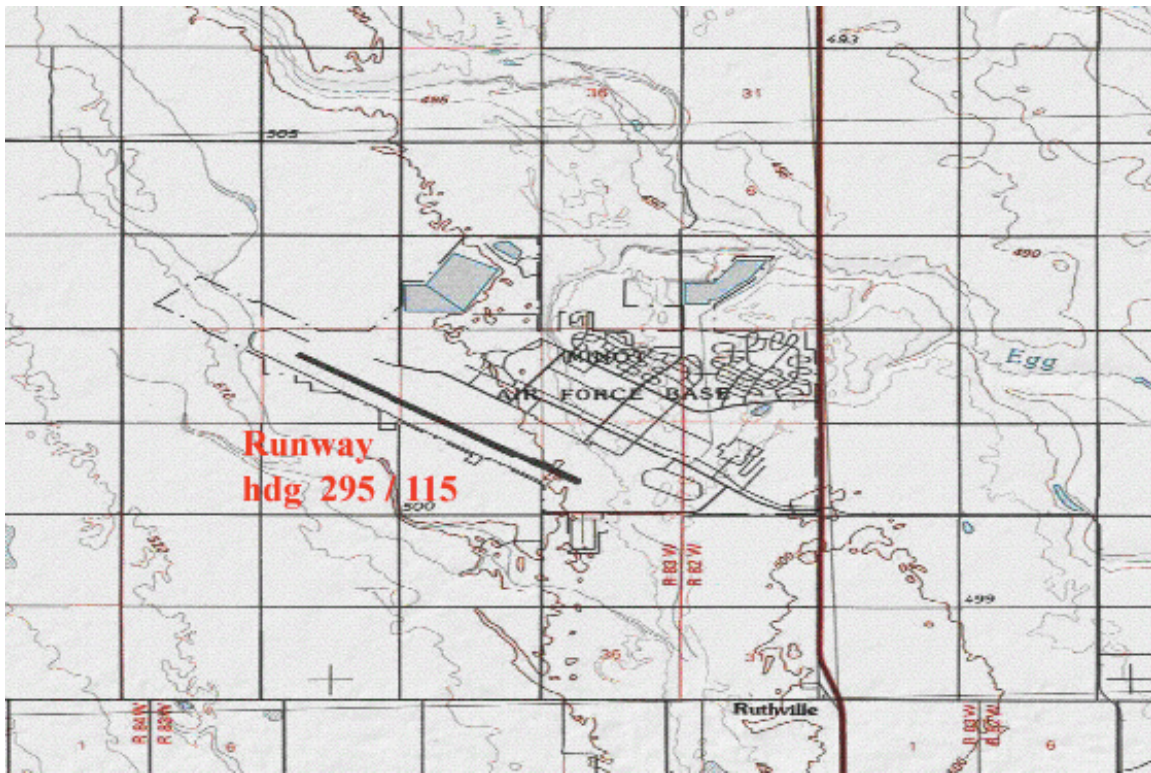

Figure 4. Map providing an aerial view of Minot AFB.

What is apparent is that there is only one runway at Minot AFB. When we compare the course of this runway to the cross rulings, we determine 115 / 295 degrees, which corresponds to information in the documents. Note also that the roads on the map are parallel to the cross rulings, which means that they are oriented N-S / E-W, as is customary in the USA, however, it is curious that the cross rulings are rectangular. By American standards, cartographic cross rulings are generally square with every square measuring one or two statute miles per side [a statute mile is equal to 1609 meters, not to be confused with a nautical mile (nm) which is 1852

meters]. It is also unusual that the runway is not at right angles with the taxiways. I therefore adjusted the pixel scale of the map and corrected the cross rulings.

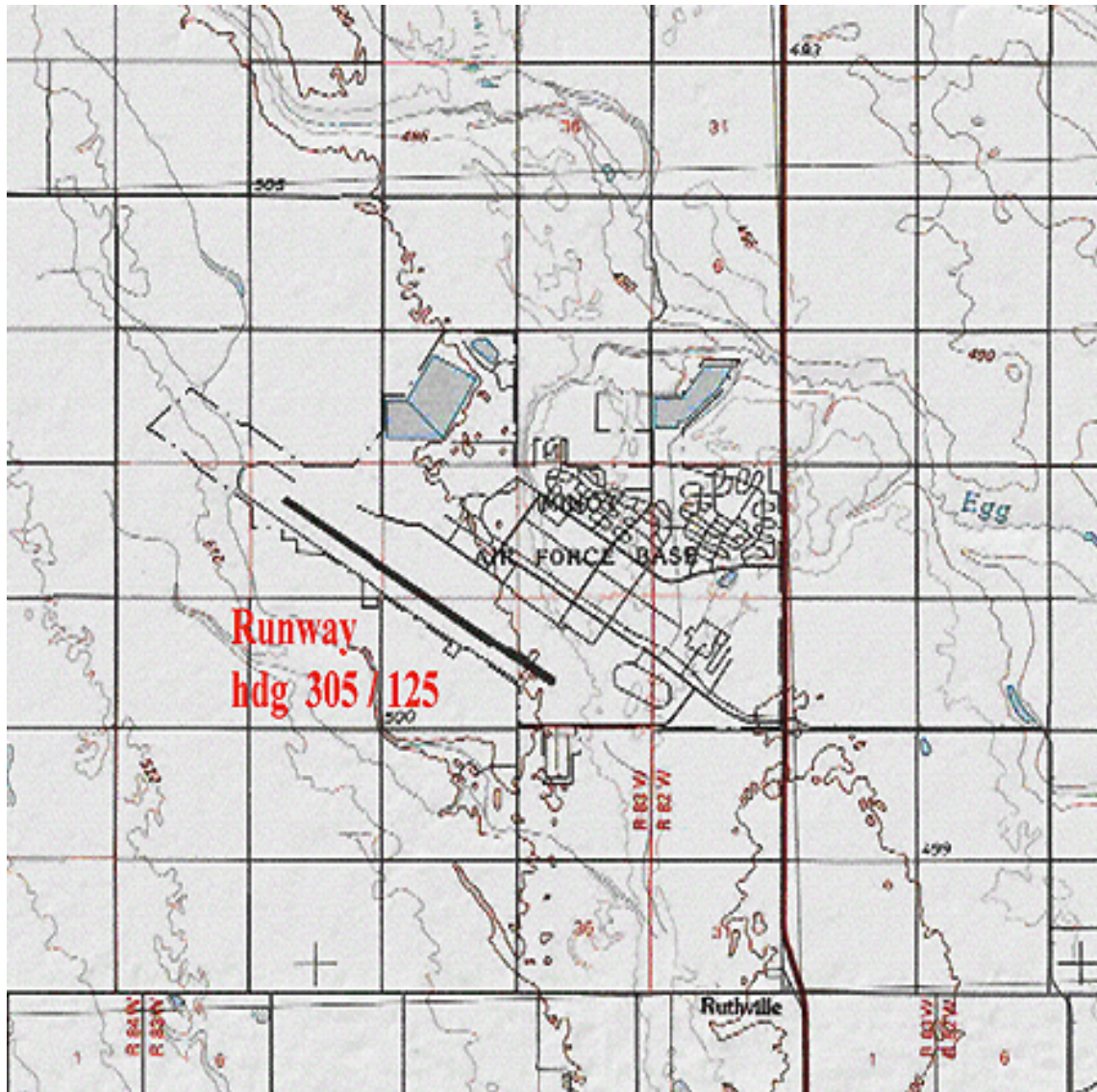

Figure 5. Drawing of Figure 4 modified in height.

The adjusted map in Figure 5 shows that the runway approaches are at right angles to the cross rulings and the written indications seem adequate. The orientation of the runway is actually 125 / 305 degrees true, which corresponds to the neighboring international civil airport and the orientation of the trajectories of the map in Figure 1. Later, I confirmed this with another map of

Minot AFB forwarded by Tulien and Klotz. On this particular map the cross rulings are in statute miles; N-7 is indicated, and the position of the UFO at the time of the B-52 flyover is plotted.

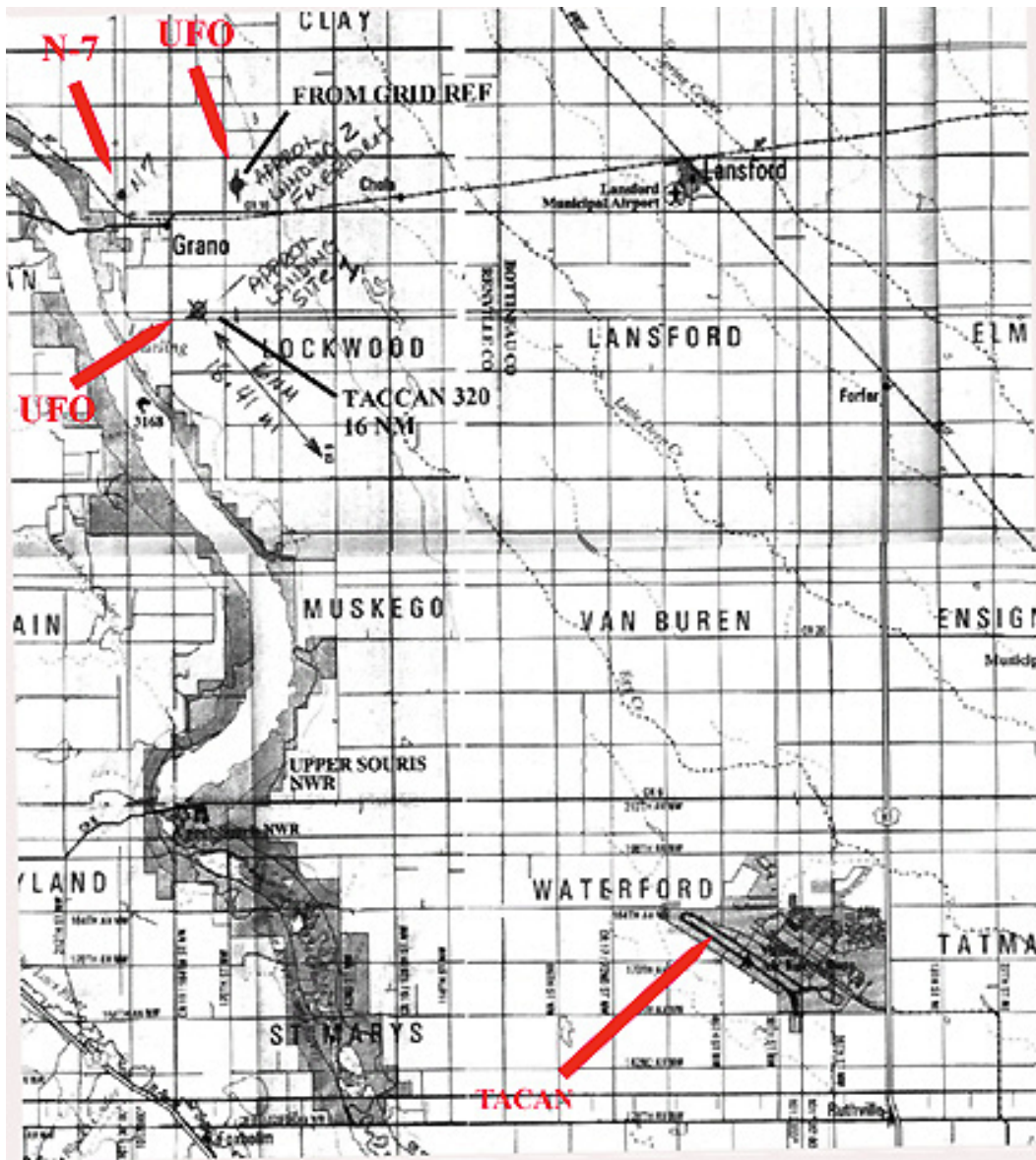

Figure 6. The area of observation with cross-rulings oriented NS / EW in statute miles. The orientation of the runway is exactly 125 / 305° true. The two positions of the stationary UFO (landing sites) are from the documents: "TACAN, 320 radius, 16 nmi" (Memo, 1 Nov. 68a, 1); and map grid "AA-43" (WSC summary). Site #1 is also the general location of the UFO observed for over an hour by personnel at N-7.

Finally, I located an aerial photograph of Minot AFB, which further confirms the accuracy of the previous maps.



Figure 7. Satellite image of Minot Air Force Base. The runway length is 13,197 feet (2.5 miles, or 4.02 kilometers).³

1.2. Additional Radar Systems at Minot AFB

According to the account described in the Blue Book documents, only the B-52 onboard radar and a weather forecast radar system detected the UFO. I find this difficult to accept since Minot AFB was a principal Strategic Air Command base with fifteen B-52 nuclear bombers and 150 Intercontinental Ballistic Missiles (ICBM) on constant alert. It is hard to imagine that in such an environment at the height of the Cold War there were no surveillance radars that detected potential enemy planes, incoming missiles, or for that matter, UFOs. Nonetheless, for lack of additional documentation, we must content ourselves with the radarscope photographs filmed onboard the B-52.

³ Map source: <http://www.bing.com/maps/?cp=48.415500%7C-101.357667&style=h&lvl=14&v=1>.

1.3. The Two-Mile Jump of the UFO

The Blue Book documents indicate that near the completion of the 180-degree turnaround over the TACAN initial approach fix (colloquially referred to as the *WT fix*) the B-52 radar operator observed the UFO on his radarscope and noted its distance at 3 nm (5550 meters) to the left of the aircraft. However, during one 3-second sweep of the radar, he noted that the UFO was now located at a distance of only 1 nm (1852 meters), still to the left of the aircraft. According to the map in Figure 1, the UFO would have then remained at the same distance and relative position pacing the B-52 for the next 38000 meters (23.6 mi.). The average distance between the B-52 and the UFO along the parallel trajectories is actually 1930 meters (1.04 nm), which is relatively close to the 1 nautical mile stated in the documents.

Figure 1 also shows two successive radar positions of the UFO in relation to the B-52, which are indicated by two crosshairs (x) in the upper left corner near the WT fix. The distance between the position of the UFO and the aircraft along the dotted lines is exactly 6100 meters. As a result, the UFO would have moved from 6100 to 1930 meters, traveling 4170 meters towards the B-52 in less than three seconds. According to Newton's law, the most reasonable proposition would assume an equal acceleration and deceleration, and would therefore have to be made in two steps.

- **Acceleration in 1.5 seconds for half of the distance (2085 meters).**
- **Deceleration in 1.5 seconds for an equal distance (2085 meters).**

Acceleration (**A**) is simple to calculate:

- **$A = 2 \cdot 2085 / (1.5)^2 = 1853 \text{ m} / \text{s}^2$, which is equal to 189 g.**⁴

⁴ The acceleration that Earth's gravitational field exerts on objects at Earth's surface (9.8 m/sec²). Also used as a stress measurement for bodies undergoing "loads" imposed on an aircraft or pilot. Loads may be centrifugal and

In the course of this very strong acceleration, the speed (**V**) attained by the UFO was at maximum velocity in midcourse:

- **V max = 1853 . 1.5 = 2780 m/s or 10,000 km/h (6214 mph; Mach 8, or eight times the speed of sound).**

These preliminary results suggest that at the very least the crew of the B-52 should have heard a loud sonic boom; yet no such sound was actually reported (as is often the case with UFOs). As we will eventually see, it also appears that the UFO had sufficient power to achieve an acceleration that would theoretically allow an interstellar voyage.

It needs to be noted that the speed provided in the documents by the Minot AFB officer in charge of the investigation, Col. Werlich, of 3000 mi./hr (4827 km / h) appears wrong, possibly because the necessary two steps of acceleration and deceleration were not taken into account (4170 m in 3 seconds = 5004 km / h; or 3109 mph). Moreover, if both of the crosshairs drawn on the Figure 1 map for the position of the UFO are weather radar positions, then the acceleration would be higher, because the UFO jump represented by a segment of the trajectory in Werlich's overlay has a length of 6400 meters. This would correspond to:

- **A = 2 . 3200 / (1,5)² = 2844 m / s², which is now 290 g.**

The maximum speed would then be 4266 m/s, equal to Mach 12, or 15000 km / h (9321 mph). As we will see by analyzing the actual radarscope photos taken onboard the B-52, the speed of the UFO and its acceleration can be calculated more accurately by using less controversial methods.

aerodynamic due to maneuvering. (For example, 7 g is a load 7 times the weight of the aircraft. A typical person can handle about 5 g (50m/s²) before losing consciousness. Modern pilots can typically handle 9 g (90 m/s²).

1.4. The UFO Landing Zone

The position of the rectangle, drawn by Werlich on the overlay map indicating the “probable area of aircrew ground sighting,” is shown in Figure 8. This is the area where the B-52 pilots observed the UFO on or near the ground during the flyover at low altitude. Also indicated are two other landing site locations provided in the Project Blue Book documents.

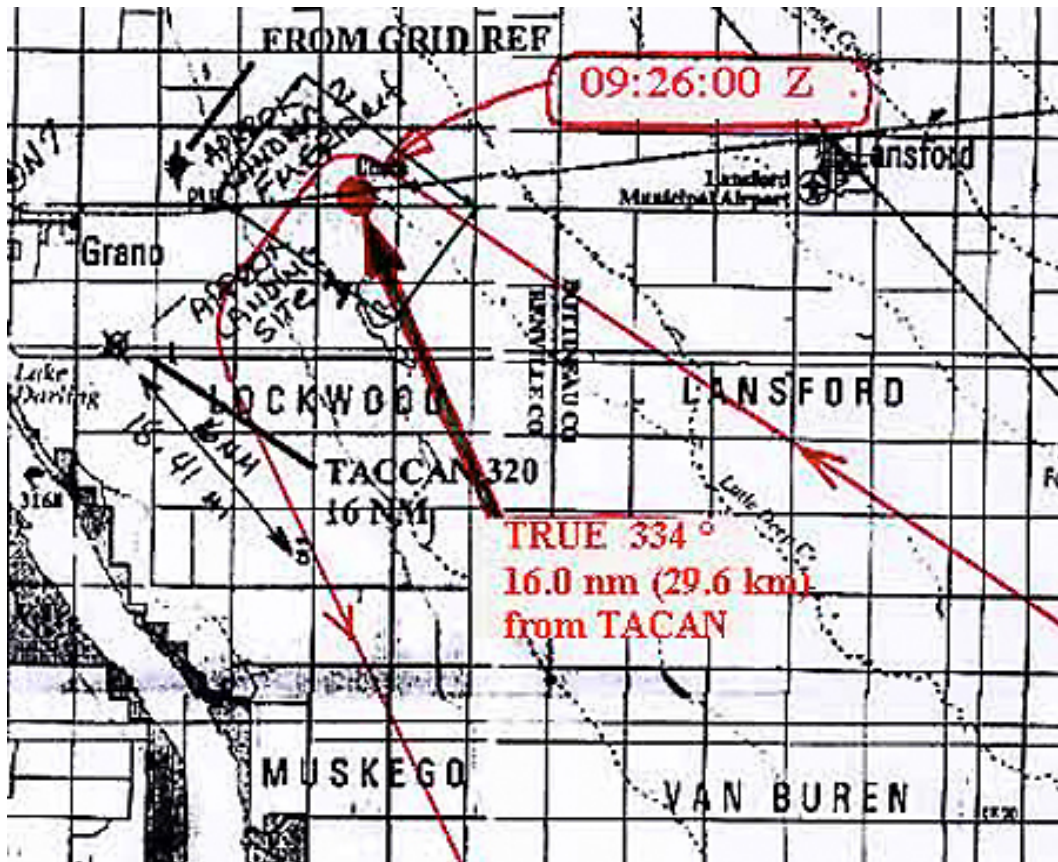

Figure 8. The three indicated landing locations of the UFO.

The cross rulings on this map are in statute miles and equal 1609 meters. The coordinates of the landing area situated to the northeast of Grano, ND, are relative to the Deering TACAN transmitter adjacent to the runway at 37% of the length from the northwest end. Werlich indicated the landing area as being 16 nautical miles (29.6 km) from the TACAN transmitter at 320 degrees radial. How this position was obtained is not stated in the Blue Book documents,

however, it is possible that there is an error in the 320 degrees azimuth as a result of confusion between the magnetic and true azimuth.⁵ The difference would be $334 - 320 = 14$ degrees, which is close to the 13 degree magnetic declination for Minot at the time. The northwest landing area (AA-43) is indicated from its coordinates on the grid map. This location is provided in the documentation in the summary that was apparently prepared and submitted by the 91st Strategic Missile Wing, Security Controller. The original source of this information is not specified.⁶

1.5. The Two VHF Transmission Failures

During the two occasions when the B-52 was in close proximity to the UFO, the B-52 VHF radio transmission with Radar Approach Control (RAPCON) was interrupted, while the reception of incoming communications was unaffected. These communications took place on a stated UHF military frequency, although they were actually in the VHF band at 270 Mhz.⁷

The first loss of radio transmission occurred near the WT fix, at the time when the UFO closed on the B-52's left wing, reducing its distance from 3 to 1 nautical mile (nm). The loss of transmission continued for more than 16 nm, or about 4 minutes, if the airspeed of the B-52 during the descent to the runway was 250 knots (460 km / h, or 285 mph). This speed is plausible

⁵ Memo for the Record, 1 Nov. 1968a, *Subj: Need for Additional Info on Minot Sightings*, 1. Available from: <http://minotb52ufo.com/pdf/0012.pdf>. An azimuth is the horizontal component of a direction measured around the horizon clockwise, from the north (0°) toward the east, and from the south (180°) toward the west. Magnetic declination is the angle between magnetic and true north, and considered positive east of true north, and negative when west. As a result of the Earth's magnetic poles wandering slowly over the years, magnetic declination changes over time and location. Declination for Minot AFB (48.25° N- 101.21' W) in October 1968 = 12° 50' E changing by 0° 3' W/year. (See: National Geophysical Data Center from: <http://www.ngdc.noaa.gov/geomag/>).

⁶ Wing Security Controller summary, *On 24 Oct 68 the following personnel*, n.d. from: <http://minotb52ufo.com/pdf/0015.pdf>.

⁷ In principle, the "academic" border between UHF and VHF is 300 Mhz. However, the USAF uses frequencies below 270 Mhz and above 360 Mhz, and appears to use the same name (UHF) for both bands. (The B-52 EWO Capt. Goduto operated the 360 Mhz HF radio). It is notable that the VHF (radio) reception by the B-52 was not affected, nor the transponder affected, since it was used to communicate with RAPCON during the transmission failure. Also, the B-52 radar detection was unaffected.

because the B-52 was descending from 20,000 to 3200 feet. As soon as the UFO disappeared from the radarscope, VHF communications returned to normal.

The second instance occurred when the B-52 was at its closest proximity to the UFO during the flyover at 4:35 (CDT), at an altitude that was less than 1 nm.⁸ In both instances, neither the onboard instrumentation, nor the radio *reception* appeared to have been affected. Taken together, these two VHF transmission failures pose an interesting physical effect that will be examined in more detail later in this study.

Even though we have witness accounts and post-event interviews of the UFO observation, we should note that these accounts are not always concomitant with the physical data. Because the UFO observation provides us with exceptional physical evidence, specifically 14 radarscope photographs, as well as transcriptions of radio communications between the RAPCON ground controllers and the B-52 co-pilot, we shall rely primarily on this physical evidence in our following analyses.

1.6. Observer Accounts of the UFO Events

Numerous ground witnesses at various locations, as well as the B-52 pilots, observed the bright luminous UFO and reported its movements over a period of three hours. Eight witness accounts are presented in **Appendix 3: Observer Accounts of the UFO Events From the Documentation**, seven of which are extracted from the Project Blue Book *AF-117 Sighting of Unidentified Phenomena Questionnaire*. During the Blue Book investigation, the B-52 pilot Major James Partin also completed the AF-117. Partin was not a regular crewmember, but was onboard during this particular mission being evaluated by the B-52 aircraft commander, Captain

⁸ 4:30-4:35 is the time noted in Partin's AF-117 for the air-visual observation. Available from: <http://minotb52ufo.com/pdf/0024.pdf>. According to our reconstruction of the B-52 flight track the time of the radio transmission loss would be about 4:27 (0927Z). See: Appendix 1.

Don Cagle. None of the six regular crewmembers, including copilot Capt. Bradford Runyon, were interviewed during the Blue Book investigation. However, Thomas Tulien for the Sign Oral History Project (SOHP) recorded interviews with Runyon on 5 May 2000, and 25 February 2005, and extracts from the transcripts have been included in **Appendix 3**. Rather than a chronological narrative of the events, the documents provide a database of the various witness accounts.

1.7. The Question of the Stars Sirius and Vega

In his final report, Quintanilla concludes that during the sighting period the ground witnesses were either viewing a celestial object or the B-52, and that the pilots could have been observing Vega during the air-visual observation.

The ground visual sightings appear to be of the star Sirius and the B-52 which was flying in the area. The air visual from the B-52 could be the star Vega which was on the horizon at the time, or it could be a light on the ground, or possibly a plasma.⁹

In other words, for over three hours on this particular morning, at least 18 witnesses were unable to distinguish a common celestial object, and/or a B-52 on a routine flight path (with and without its landing lights on). We should keep in mind that it was quite typical of Blue Book to ignore witness reports and relevant empirical data, presumably because the reported phenomenon does not support a conventional explanation. Be that as it may, let us explore the final conjecture made by Quintanilla that the observed phenomenon was indeed a star. The two possible stars suggested by Quintanilla are Sirius and Vega, which were visible during the sighting period and most prominent in order of brightness. The Minot AFB coordinates I have used are:

- **North latitude = 48.447682 degrees**

⁹ Quintanilla, Hector, Jr., 13 Nov. 1968, *UFO Observation, 24 October 1968* (Project Blue Book final case report with attachments). Available from: <http://minotb52ufo.com/pdf/0028.pdf>.

- **West longitude = 101.2669479 degrees (6 hrs, 45 min, and 4 sec.).**

Following are the positions of the stars Sirius and Vega at the time of the observations on 24 October 1968 Azimuth (Az) is ascertained from the geographical north in a clockwise direction, and altitude (alt) corresponds to the height above the horizon. These are the star positions during the initial observation by Smith, Isley, and O'Connor at 2:30 a.m. (CDT; 07 h 30 Z [GMT]).

- **SIRIUS Az = 126° alt = 9° (About 10 cm at arm's length)**
- **VEGA Az = 308° alt = 9° (About 10 cm at arm's length).**

As a result, Sirius was in the *southeast* sky (rising to its culmination in the south), and VEGA in the *northwest* sky (descending to below the horizon in the north). But Isley and O'Connor reported their initial observation of the UFO in the east, while traveling south towards N-7, which does not correspond to the directions of either star. In addition, let us not forget that at least 18 witnesses reported the angular size of the UFO in the order of **23 to 70 minutes of arc according to the location of observation.**¹⁰ By comparison, the angular size of the moon is about 30 minutes of arc, so these reports do not correlate to a point star with a null angular size.

Let me point to additional data that further disprove that the object could have been a star. 09 h 28 Z (4:28 a.m. CDT) is the time of the fly-over and air-visual observation of the UFO from the B-52.

- **SIRIUS Az = 159° alt = 22° (About 25 cm at arm's length)**
- **VEGA Az = 340° alt = under the horizon.**

¹⁰ See Appendix 3. The Wing Security controller also lists observers at Mike and Juliet-Flights, and the camper team at O-6. Several compared the size to a KC-135 Stratotanker aircraft.

These data clearly show that VEGA was in fact not even visible to the B-52 pilots at the time of the reported observation. Also, the B-52 flew *directly towards* the UFO on a heading of 290° (WNW), and VEGA (at more than 340°) would have been to the right of the aircraft.

In the Blue Book final report, Quintanilla documents the positions of the stars at 08 h 00 Z (3:00 a.m.) as follows:

- **SIRIUS Az = 138° alt = 28°**
- **VEGA Az = 331° alt = 4°.**

However, these results are clearly inaccurate since the altitude angle of culmination of a star is determined by: $\text{alt} = 90^\circ - \text{latitude} + \text{declination}$. The culmination of Sirius at Minot AFB at the time of the observed phenomenon was:

- **$\text{alt} = 90^\circ - 48.45^\circ - 16.71^\circ = 24.84^\circ$.**

The altitude of Sirius could not have exceeded to 28° as stated by Blue Book. It is possible that their astronomical calculation reflects an incorrect latitude value by 3.16° towards the south, which is a position error of 350 km for Minot AFB. For 08 h 00 Z, with the coordinates for Minot AFB we actually find:

- **SIRIUS Az = 134° alt = 13°**
- **VEGA Az = 316° alt = 6°.**

Screen captures of the positions of Sirius (2:30-5:30) and Vega (2:30-4:30) from the perspective of the observers at N-7 during the time of the observations are available from:

- **SIRIUS:** <http://www.minotb52ufo.com/investigation/sirius.php>; and
- **VEGA:** <http://www.minotb52ufo.com/investigation/vega.php>.

Part 2. General Descriptions of the B-52 Radarscope Photographs

2.1. Description of the B-52 Radarscope Photographs

Generally, I agree with Shough's expert analysis of the B-52 radar system (ASQ-38), and interpretation of the photos. Accordingly, I will concentrate on my own independent analysis of the sequence of 14 radarscope photos (771-784) filmed onboard the B-52.

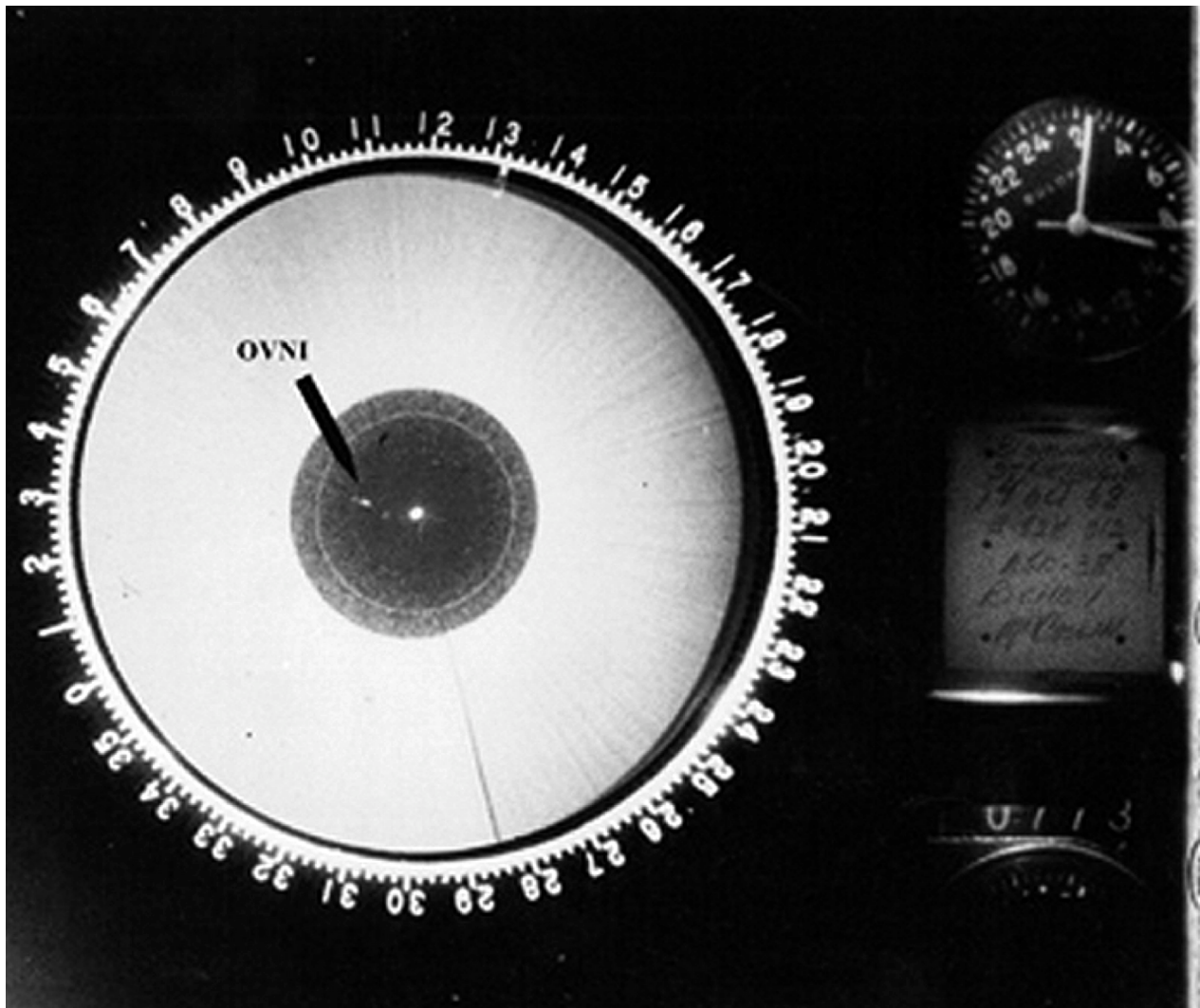

Figure 9. Photo #773. Each photo displays a chronometer, data plate, and counter that are superimposed onto the film. As a result, we know we have photos of 14 successive radar antenna rotations from this particular mission. The intense radar echo of the UFO (OVNI in French), is located one nautical mile to the left of the B-52 at $\sim .040$ degrees

At the time of the UFO events, the radar navigator switched the radar system to “Station-keeping” mode, whereby the radar coverage is elevated and concentrated close to the aircraft. In this mode, the Plan Position Indicator, or radarscope display, draws a concentric map that has as its center the position of the aircraft, oriented according to its heading. In this instance, the right edge of the screen is a bit askew, possibly due to the fact that photographs were acquired from the back of the cathode-ray tube by means of prisms and lenses, which does not permit an axial photo of the screen image. However, the deformation caused by the oblique view is well corrected. The photograph is exposed for a time exposure of three seconds, which corresponds to one complete rotation of the radarscope’s radial sweep. The sweep is synchronous with the rotation of the radar antenna located beneath the nose of the B-52. The technical manual for the radar indicates that the rotation is clockwise, which is confirmed by the progressive increase of brightness of the ground echo. The radial sweep is visible by the inclined radial line at 284 degrees, which is the point where the camera shutter briefly closes during the next film frame advance. Because the radar screen contains phosphorus with a long persistence, the beginning of the rotation is more intense due to its extended exposure.

The photo is exposed on 35mm black and white negative film, which was developed after the flight and subsequently interpreted by an intelligence officer. Aside from the clock, informational data plate, and frame counter, these photos contain specific information including the heading of the aircraft, and the distance and azimuth of the radar echoes. The radarscope is calibrated for distance by visible concentric circles (i.e., range markers) at 0.75, 1.25, and 1.75 nm from the center, and to a five nm circumference at the outer edge. We can also calculate the specific altitude of the B-52 at the time of photo in relation to the altitude hole, which decreases in diameter as the B-52 descends in altitude.

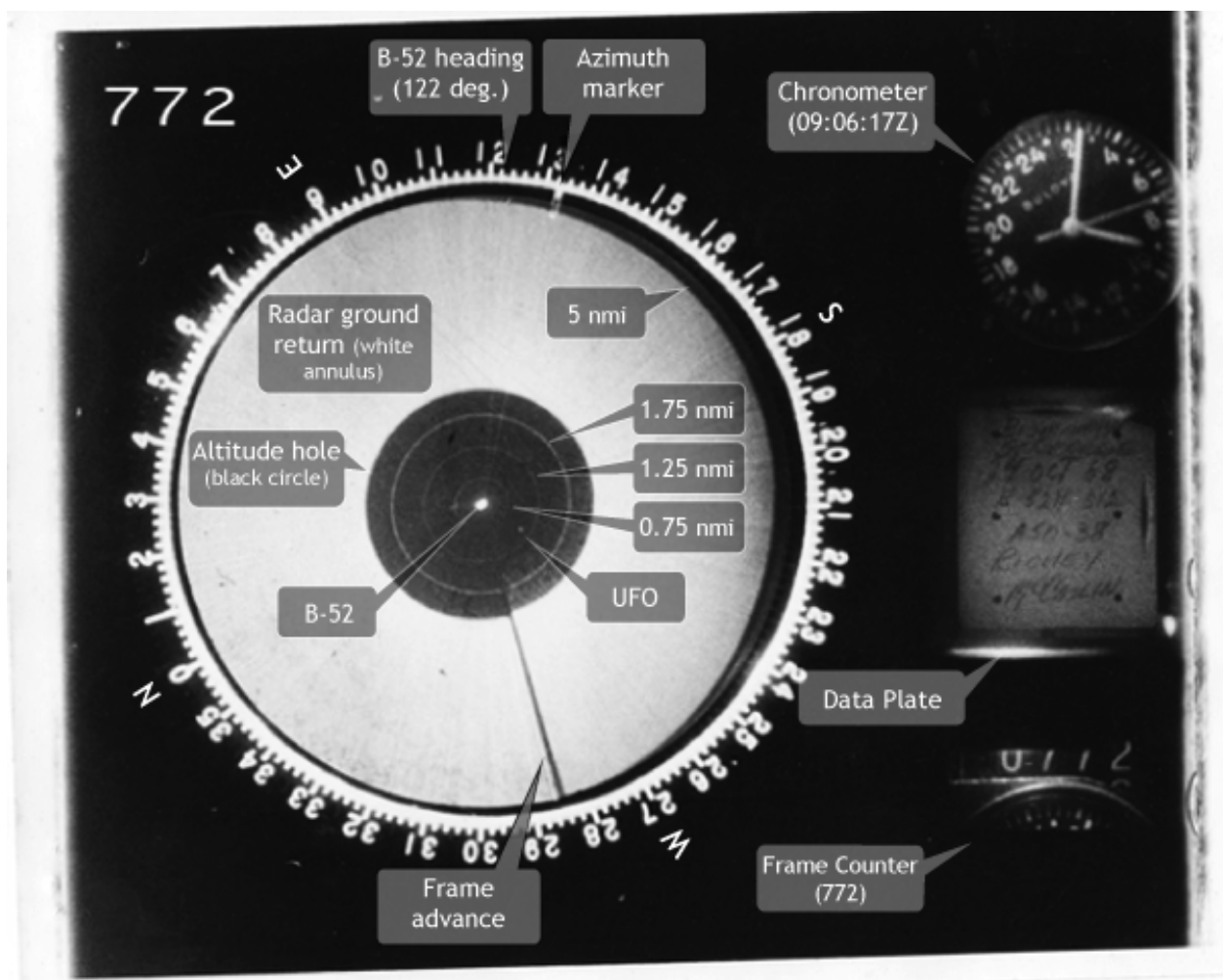

Figure 10. Station-keeping mode of radar operations. The B-52 radarscope consists of an illuminated bearing ring and 10-inch diameter tube face called a Plan Position Indicator (PPI). The chronometer, data plate, and counter are superimposed via a separate optical path. The time on the twenty-four clock is 090620Z (4:06:17 CDT). Below it, the handwritten data plate identifies locations in the flight plan (Bismarck and St. George); the date (24 Oct. 68); aircraft identification (B-52H 012); radar system designation (ASQ-38); and names of the operators (Richey and McCaslin). The counter identifies the frame as #772. The B-52 is the bright spot in the center of the radarscope, on a heading of 122 degrees (0 degrees is north). The UFO echo appears at 242 degrees azimuth, 1.05 nautical miles (nm) aft of the right wing of the B-52. The black circle in the center is the "TR hole" (transmit/receive) or "altitude hole," and the white annulus extending five nm out to the edge of the bearing ring is radar ground return. There are three inner range rings visible within the altitude hole corresponding to .75, 1.25, and 1.75 nm. The diameter of the altitude hole decreases as the B-52 descends in altitude. The radial line at 284 degrees is the point where the next frame advances in the camera to begin another three-second time exposure, corresponding to the clockwise rotation of the radar antenna mounted beneath the nose of the B-52. The marker at 132 degrees is a manually adjusted azimuth marker.

The heading of the aircraft is towards the top of the photo, so what we see on the scope is the actual orientation of the echoes in relation to the aircraft. The heading at the top appears to

be 118 degrees, however, there are two visible lines that extend out from the center in the direction of the flight. Extending the left line determines a course of 122 degrees, whereas the right line corresponds to a marker at 132 degrees. This is a bit confusing, and the lines and concentric range markers are not always visible in the photos, particularly in the dark zone of the ground (terrain) echo, since the contrast is hidden in the noise. It is not clear if the B-52 heading indicated on the photos (122 or 132 degrees) is the true geographical heading or the magnetic heading, but it appears that 122 degrees corresponds to the magnetic orientation of the runway.



Figure 11. The counter on photo 772. We also see the top of the chronometer, probably owing to a shift of a mirror that was not correctly centered here.

The B-52s at Minot AFB were specially equipped for navigation over the northern Polar Region, where the use of magnetic navigation is useless, since the headings change continuously when the magnetic field of the Earth is practically vertical. Therefore, means of inertial navigation incorporating gyroscopes were used for accurate navigation over the Polar Regions. In principle, these systems give true course. It seems plausible that the bombing radar would be adjusted to the inertial navigation system, making the 132-degree heading the true course.

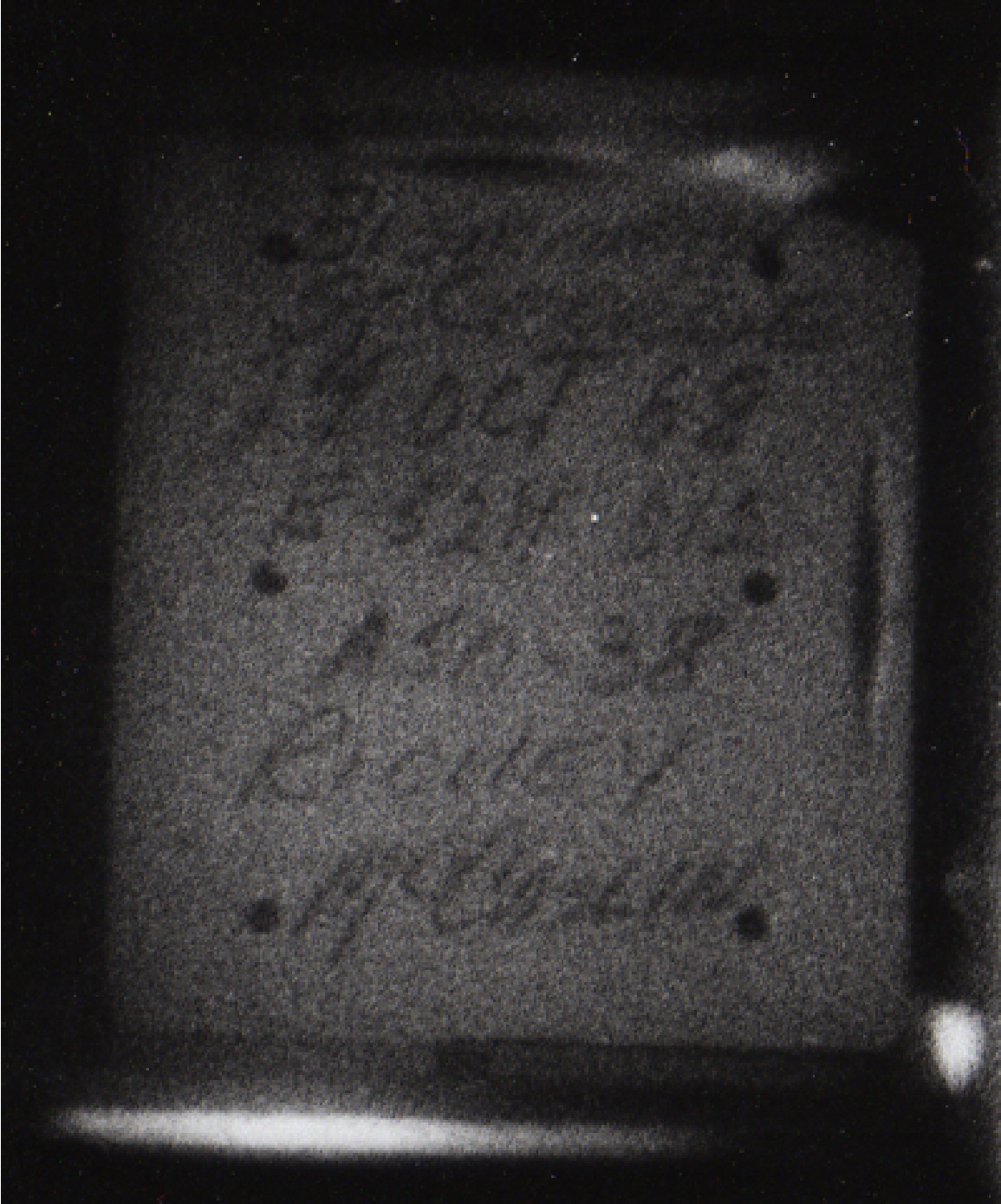

Figure 12. Data plate. Thirteen of the photographs (771-783) include the same plate information, which consists of the location of the bomb training exercise (Bismarck - St George); the mission date (24 Oct 68); aircraft identification (B52H 512); the onboard radar system (ASQ-38); and the names of both radar operators (Chuck Richey and Patrick McCaslin).



Figure 13. Chronometer from photo 772. This 24-hour watch manufactured by Bulova was wound and set to Greenwich Mean Time (GMT, or Zulu) by the radar operator prior to the mission. Photo 772 was therefore acquired at 09 hr. 06 min. 17 sec. (GMT); or 4:06:17 a.m. (CDT). CDT offset at Minot, ND, is -5 hours.

2.2. Radar Echoes on the Photos

The same day of the incident, 5th Bombardment Wing, intelligence officer Staff Sgt. Richard Clark analyzed the radarscope film at the request of his superiors. Clark ordered two sets of 20 X 25 cm (8 X 10 inch) photographic prints of the 14 frames from the original 35mm

negative. He included one of the sets of prints with his report and kept the second set as a file copy. Years later, Clark gave the second set of photos to his brother-in-law, William McNeff, a representative of the *Mutual UFO Network* (MUFON) for the state of Minnesota (a private organization involved in the study of the UFO phenomenon). It was by chance that Tulien, also a resident of Minnesota, was informed of the existence of these original photos, which McNeff generously provided for analysis. In sum, the radarscope photos are first-generation photographic prints from the original 1968 film-negative.

The photographs were sent to me as digital files with a resolution of 300 pixels per inch (on average 150 pixels per nm). This allowed for repetitive distance measurements with accuracy in the order of 12 meters. According to the technical documentation, the radar has a resolution of 37 meters; so we have a resolution of the photos that is three times that of the radar. Further, I obtained extracts of the photos from Tulien with an increased resolution of 800 dpi. Following are close-ups of the successive radarscope photos indicating the various radar echoes that appear within the altitude hole.

To underscore the importance of these photographs, all successive echoes are inside the central zone referred to as the *altitude hole*, and therefore can only correspond to airborne targets. In addition, the B-52 speed was on average 460 km / h (285 mph), so that the radar target would have to maintain the same velocity in order to remain in the altitude hole (and high-acceleration when it changed position).

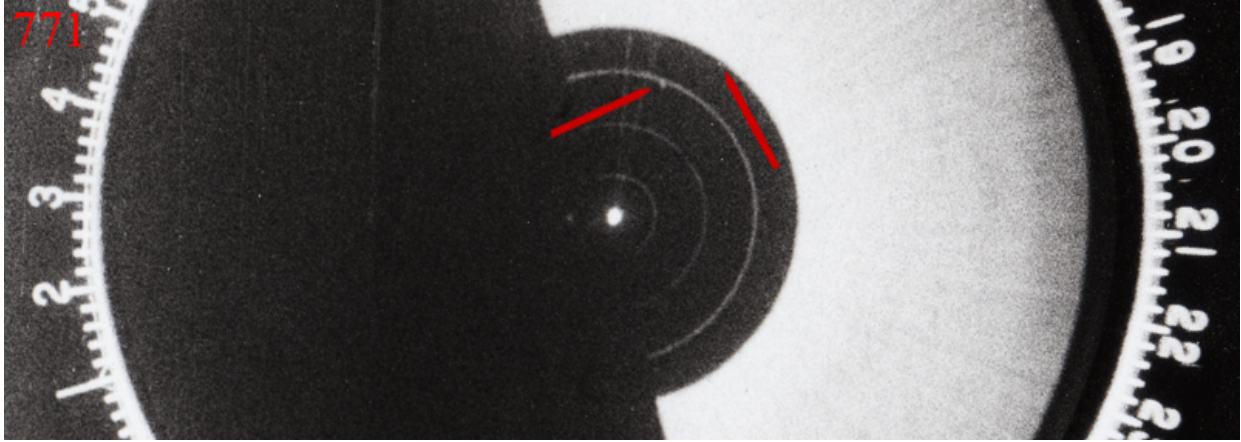

Figure 14. The echoes of photo 771. The echo on the right is most likely an artifact or small detail of the ground, because its size is at the limit of resolution of the radar and close to the altitude hole.

The position of the target is in fact an *instantaneous relative position* that is imaged at the precise instant when the radar beam swept the target. This occurs at very high speeds. For example, at the 1.75 nm range ring the sweeping speed of the beam would be in the order of 24435 km / h (15190 mph). We should also consider the size of the target that was identified by the radar beam. According to the radar operator, the size of the echo was larger than a KC-135 Stratotanker (41 x 39 meters) and therefore the target could not have been an aircraft. For example, the size of the radar echo in Figure 16 measures in the order of 280 x 140 meters, compared to the size of the B-52 measuring 48 x 56 meters.¹¹ Taken together, we know of no human device this size that can fly at the measured speed. In most of the photos the intensity of the echo is considerable, and nearly at the same level as the echo of the ground below the B-52. The UFO echo also contains some photometric structure (i.e., limb to center radar albedo increase), which further confirms that *this echo could not have been an artifact*.

¹¹ B-52 dimensions: Length: 159 ft 4 in (48.5 m); Height: 40 ft 8 in (12.4 m); Wingspan: 185 ft (56.4 m).

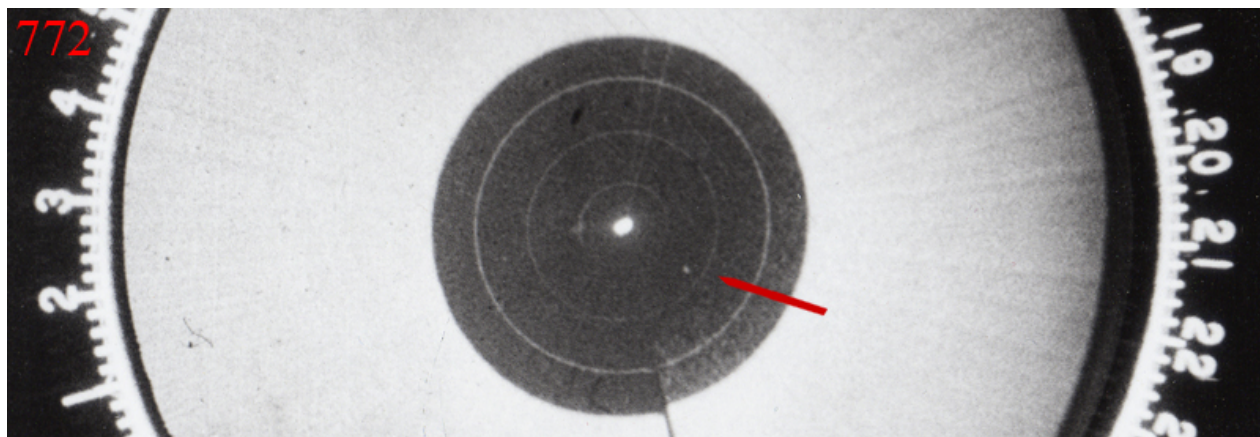

Figure 15. Echo of photo 772. Note that in three seconds the echo has changed its position 1.64 nm (3 km) and at an apparent speed of 3650 km / h (2268 mph).

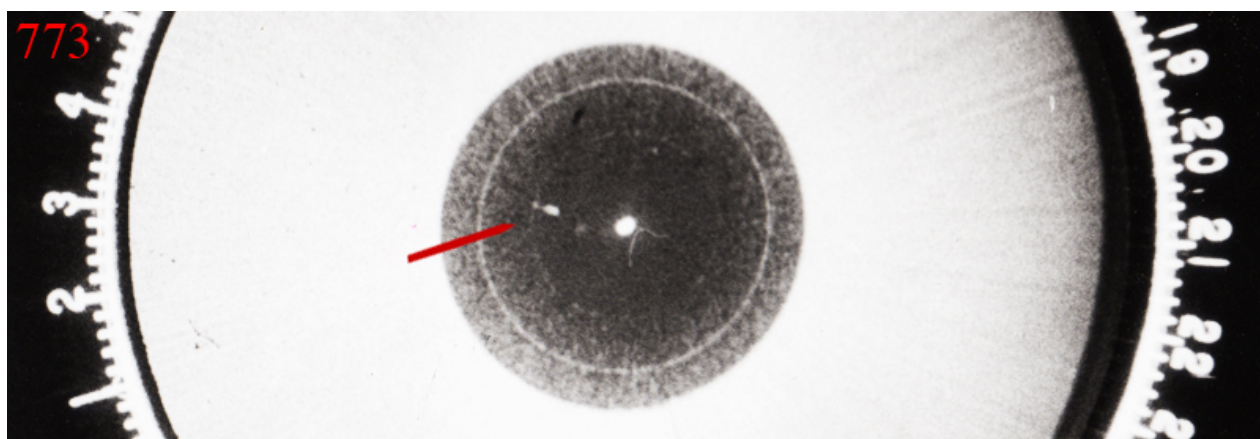

Figure 16. Echo of photo 773.

Figures 15 and 16 show that within 3 seconds, the echo made an abrupt turn and moved from the aft right to the left of the B-52, traveling 2.09 nm (3.9 km) at an apparent speed of 4600 km/h (2858 mph). The largest dimension of the echo is oriented approximately at right angles to the heading of the B-52. Figures 15 and 16 also show the echo oriented as though the UFO has traveled in the direction of the echo's largest dimension.

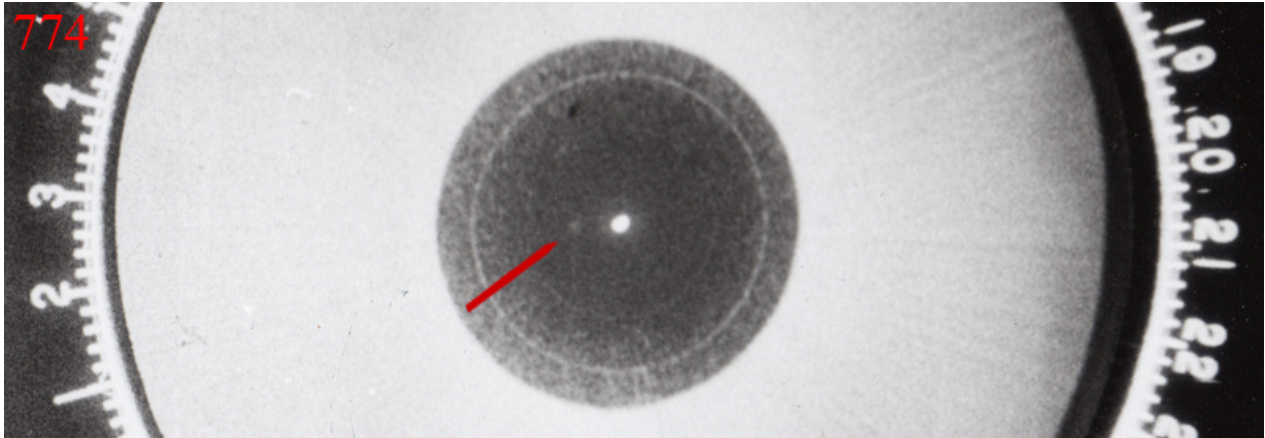

Figure 17. Echo of photo 774. The echo at 0.75 nm appears to be an artifact or light reflection occurring on all of the frames.

In photo 774 the echo has vanished. There are several possibilities for this disappearance. Either the UFO was out of the field-of-view of the radar below the aircraft, which covers only about 50 degrees in the vertical plane resulting in a blind conical zone under the B-52, or the UFO exceeded the altitude of the B-52, or was possibly beyond the edge of the altitude hole and drowned in the considerable intensity of the ground echo.

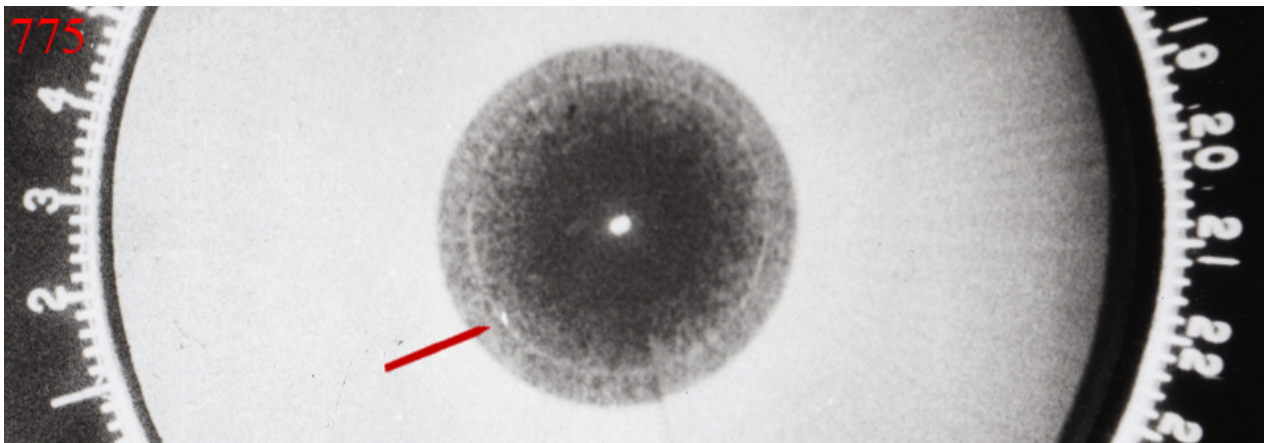

Figure 18. Echo of photo 775 is very close to the 1.75 nm distance circle. Notice that during the six seconds between photos 773 and 775, the echo has moved 1.0 nm (1.8 km) at an apparent speed of 2200 km / h (1367 mph), and we don't know where it was in the course of photo 774.

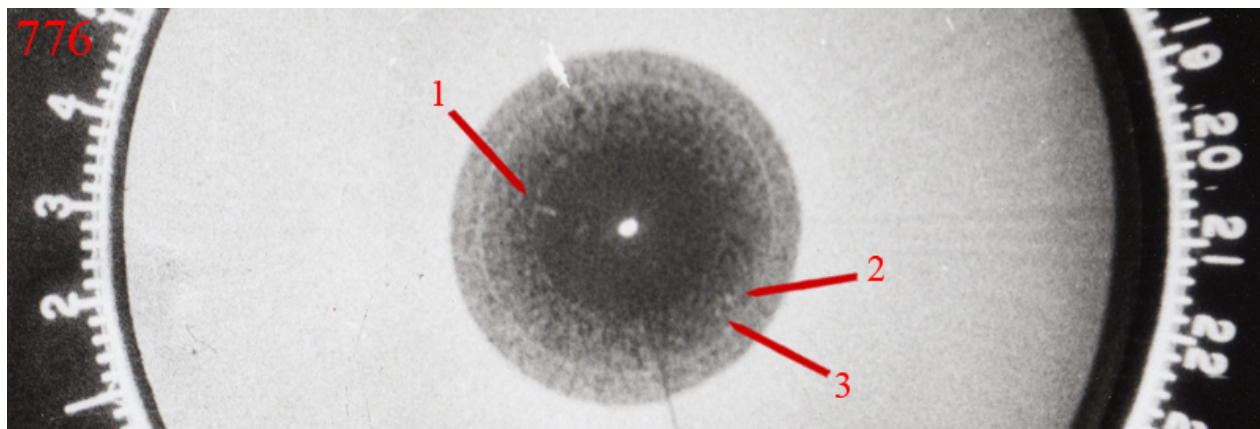

Figure 19. The echoes of photo 776. This photo is very noisy. It is likely that echoes 2 and 3 are artifacts.

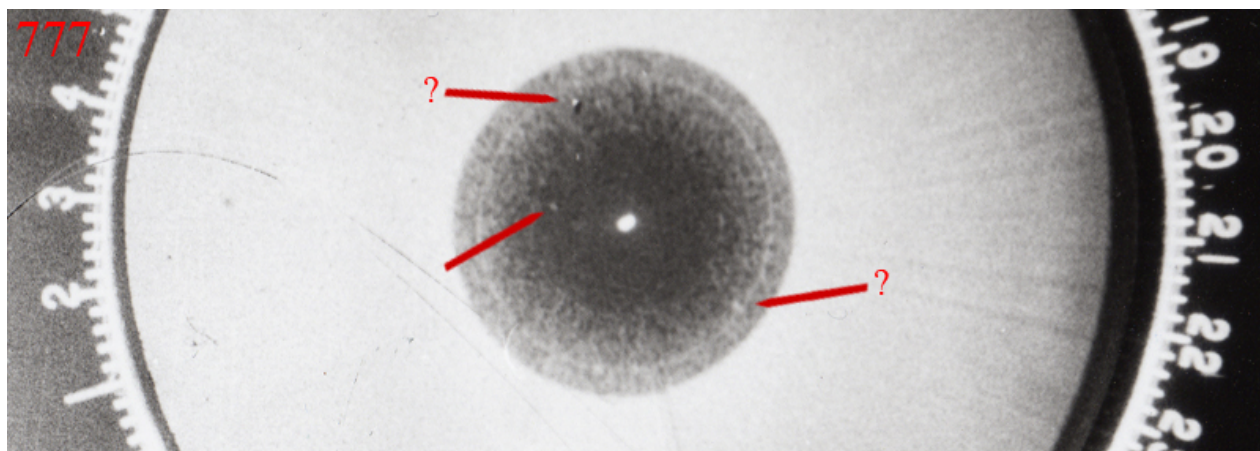

Figure 20. The echoes of photo 777. The echo to the left of the B-52 has remained. We can assume that the other two echoes are artifacts, although the size of the lower right one is quite large for a temporary noise.

The echo that recurs roughly one nautical mile to the left of the B-52 at ~40 degrees, is the only echo that consistently appears in the same place in eight of the photographs. This location of the UFO is also consistent with the documentary evidence, and the testimonies of the B-52 Navigator and Co-pilot. Nevertheless, this does not exclude the possibility that more than one UFO briefly accompanied the B-52.

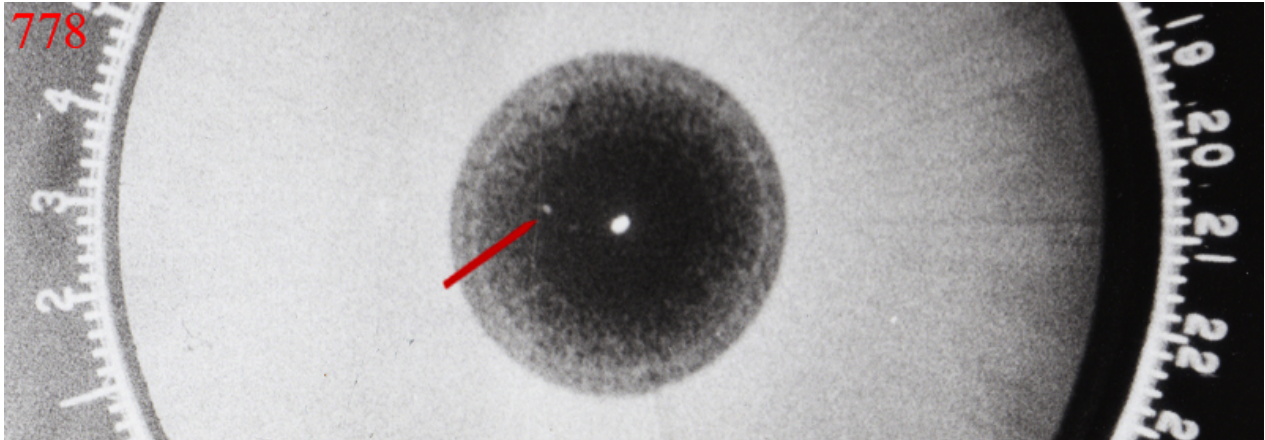

Figure 21 . The echo of photo 778

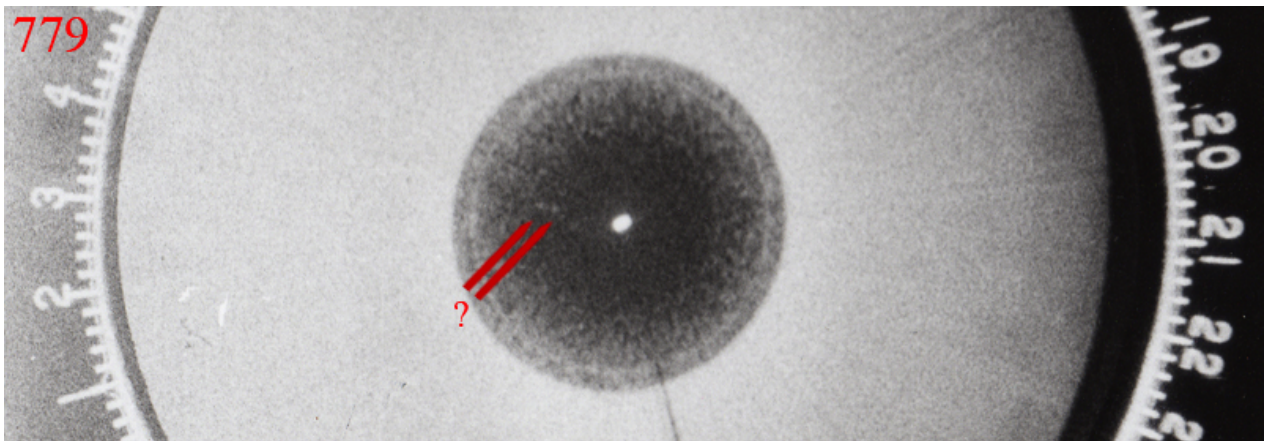

Figure 22. The double echo of photo 779.

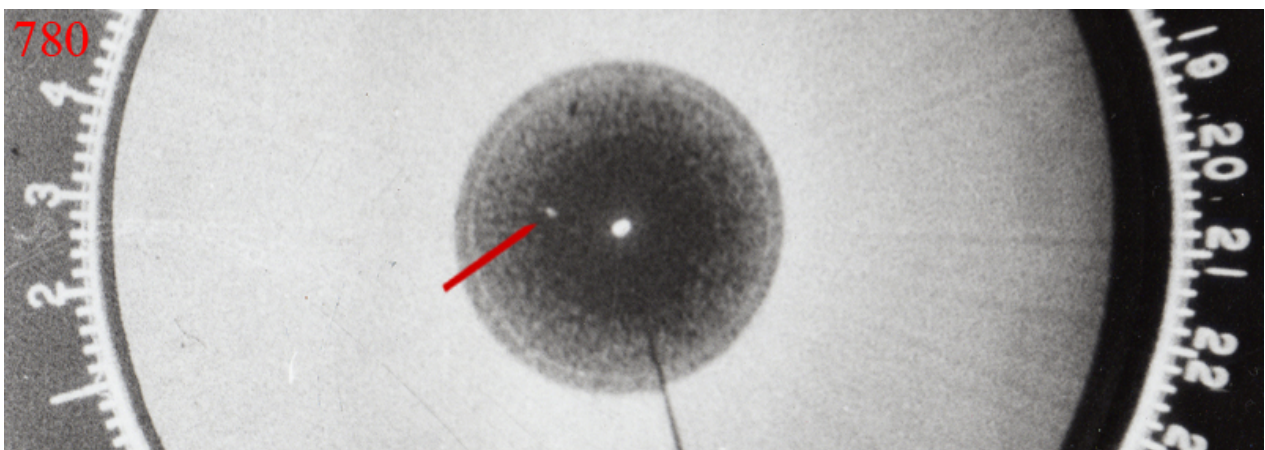

Figure 23. The echo of photo 780.

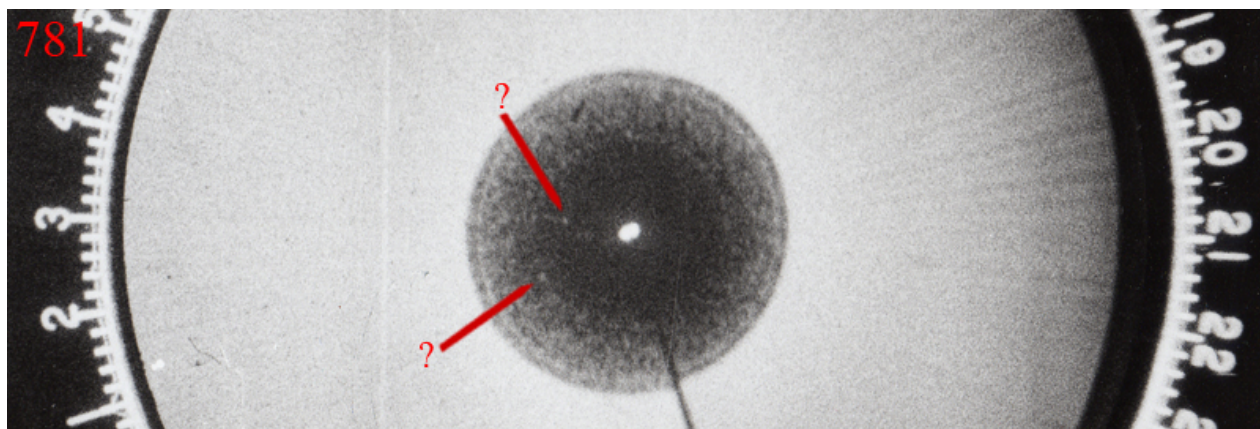

Figure 24. The echoes of photo 781. Only one echo remained at the same location. This photo is very noisy because there is a strong atmospheric dispersive effect (clouds with particles of ice) around the B-52. For this reason, the lower echo could be an artifact.

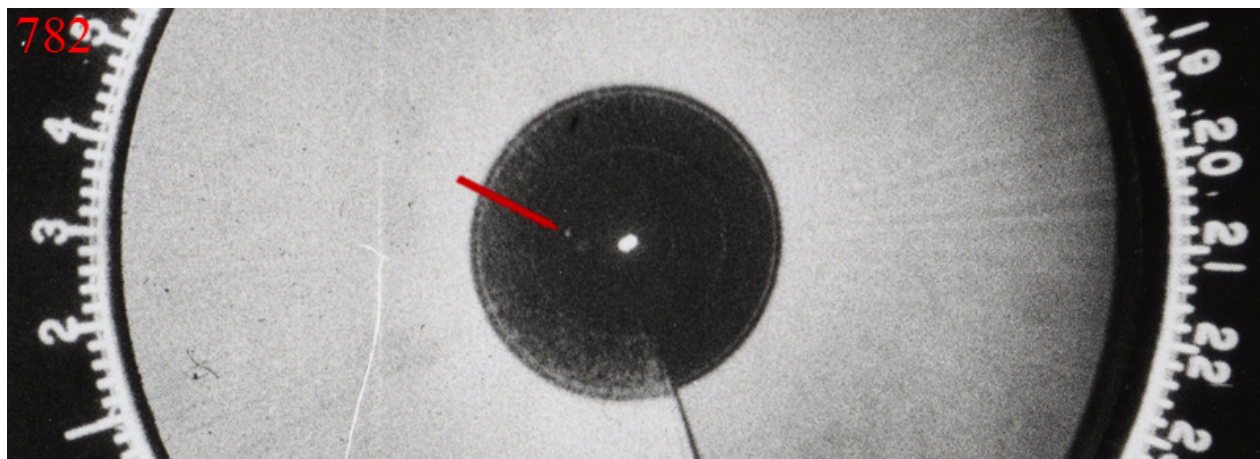

Figure 25. The echo of photo 782. The noise has decreased and the echo is distinct.

Compare the diameter of the altitude hole in 782 with the earlier photos. In this instance, the 1.75 nm distance range ring now appears near the edge of the altitude hole, confirming the descent in altitude of the B-52. Following this, the radar echo abruptly disappeared from the radarscope. At this time, the B-52 was approximately 18-19 nm from the TACAN (located adjacent to the runway), at about 9000 feet MSL, and just emerging under the overcast. The Base Operations Dispatcher directed the security and maintenance personnel at the November-7 Launch Facility to the time and location of the incoming B-52. The N-7 personnel observed and

clearly heard the B-52 high in the west, but did not observe the UFO that had been closely pacing the aircraft. At about the same time, the UFO they had been observing southeast of N-7 also disappeared from view.

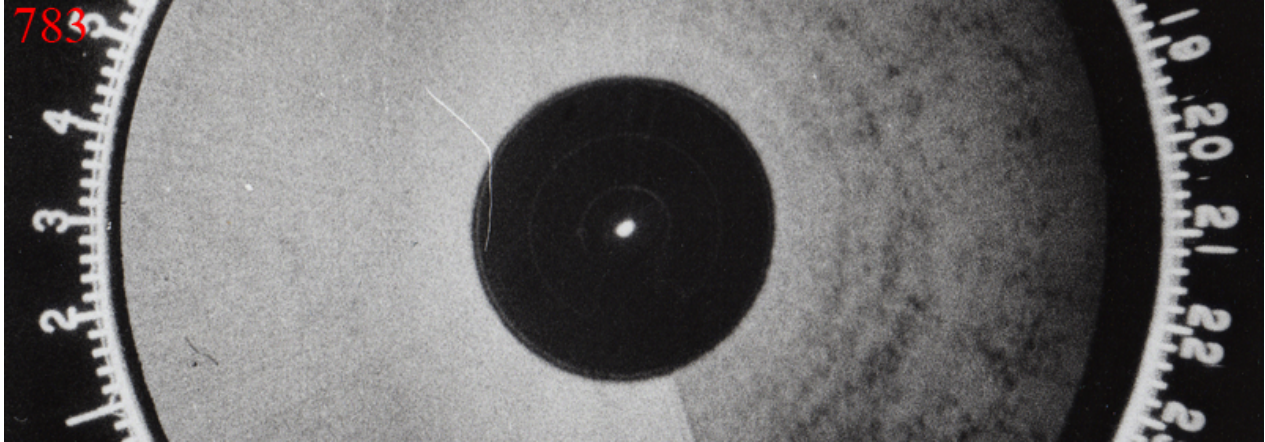

Figure 26. No more echoes on photo 783.

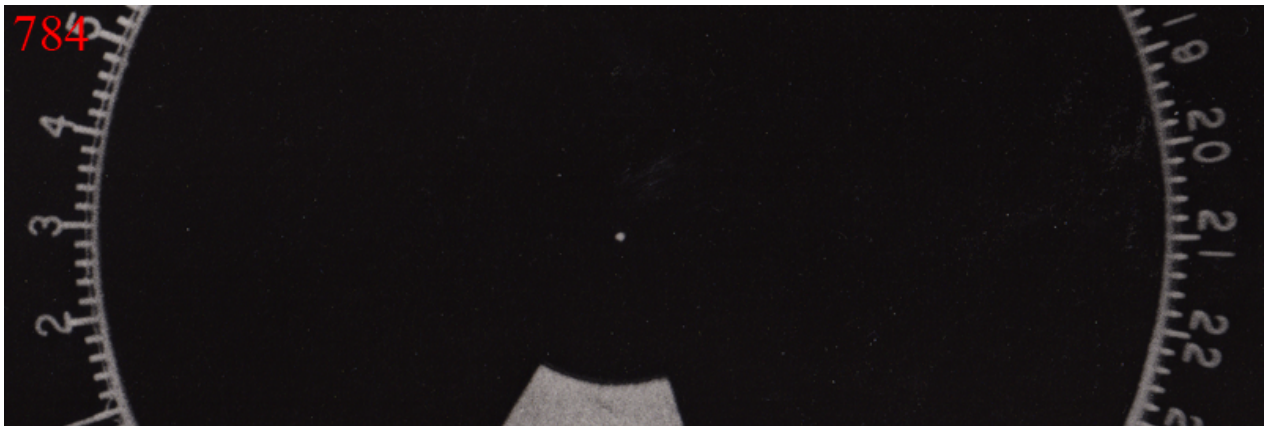

Figure 27. No more echoes on photo 784.

In the course of photo 784, the radar operator apparently switched the radar mode to sector scan (bombing assessment mode), attempting to look towards the rear of the B-52. At this time, the B-52 was approximately five minutes out from the Minot runway, intending to land after completion of a low and missed approach to the runway, and one final circuit around the traffic pattern.

2.3. Descriptive Measurements of the Radarscope Photographs

The radarscope is calibrated for distance by the concentric circles (range rings), which are located 0.75, 1.25, and 1.75 nm from the position of the B-52 at the center of the scope. These are designated in the technical training manual for the radar, and confirmed by an engineer who was responsible for the maintenance of these radars in the early 1970s.¹² (The distances have been further verified by testing their consistency with another set of possible distances corresponding to 0.5, 1.0, and 1.5 nm). I have taken careful measurements of all of the photographs, but since a long list of numbers would be of little interest to most readers they are presented in **Appendix 2** for reference.

2.4. Are These Authentic Radar Photographs From a B-52?

The photographs display an informational data plate identifying the aircraft, radar operators and date of the mission. The photos also show an echo with the classic characteristics of a UFO, and depict a descending flight pattern that is consistent with a B-52. Furthermore, the positions, altitude, and speeds are also consistent, while supported by information in the documents and the witness accounts. Since the atmosphere is rarely calm and piloting seldom perfect, one would normally expect to find small, distinctive fluctuations in the heading of the B-52. In order to examine this conjecture, the top of the calibrated circle (heading indicator) on each of the radarscope photographs was measured with the accuracy of one pixel. Following are the results:

¹² Bomb Navigation Systems Mechanic, CDC 32150K, Vol. 4 (ASB 9A/ 16), 1978; and illustration of radar Station-keeping mode available from: <http://www.minotb52ufo.com/radarscopes/radarscope-index.php>.

| N° de Photo RADAR | CAP Indiqué | Ecart |
|-------------------|-------------|-------|
| 771 | 118,2 ° | + 0.3 |
| 772 | 117,2° | - 0.7 |
| 773 | 117,5° | - 0.4 |
| 774 | 117,7° | - 0.2 |
| 775 | 117,7° | - 0.2 |
| 776 | 117,9° | 0.0 |
| 777 | 117,5° | - 0.4 |
| 778 | 117,7° | - 0.2 |
| 779 | 117,0° | - 0.9 |
| 780 | 116,4° | - 1.5 |
| 781 | 118,5° | + 0.6 |
| 782 | 118,7° | + 0.8 |
| 783 | 119,8° | + 1.9 |
| 784 | 119,0° | + 1.1 |

Table 1. Heading at the top of the calibrated circle on all of the radarscope photographs. (CAP Indiqué = top value; Ecart = variance from average of 117.9°).

The average value is 117.9 degrees (776), and the variances have been calculated in reference to this average. We can observe that the course heading changes continuously, and that a *period of variation* occurs in the order of 5 photos, or for an average period of 15 seconds. The performance of a swept-wing aircraft the size of a B-52 is typically affected by aeroelastic and pitch-roll coupling effects, which result in a dynamic oscillation known as *Dutch Roll* (i.e., http://en.wikipedia.org/wiki/Dutch_roll). The amplitude and period observed here are quite characteristic of this type of swing. Furthermore, the heading indicated in the photographs matches the trajectory from the WT fix to the runway at Minot AFB. Therefore, these

photographs are true radarscope photographs taken onboard an aircraft having the characteristics of a B-52.

2.5. Were There Two UFOs Close to the B-52?

There appear to be several UFO echoes of variable sizes in photos 771, 776, 777, and possibly in 781. These echoes seem too broad and intense to be simply instrument noise, ground terrain, or weather-related artifacts, and they do not appear in subsequent photos. In any case, it is possible that there was more than one UFO near the B-52.

Numerous ground witnesses at various locations reported observations of two similar UFOs, and we also know that ground personnel from their position at N-7 were observing a UFO in the southeast, during the same period of time that a UFO was pacing the B-52 at altitude in the northwest.

If a UFO close to the B-52 had moved away to a distance beyond the radius of the altitude hole, the echo would be drowned in the saturated radar return of the ground, and we would most likely not be able to see it on the radarscope. Furthermore, the radar could not detect anything beneath the aircraft within the blind cone of the 111.6-degree summit angle. Be that as it may, the available data do not allow us to determine whether more than one UFO was present.

2.6. Exact Time Difference Between the Successive Echoes

Each radarscope photograph is a 3-second time exposure synchronized to one clock-wise rotation (360°) of the radar antenna. The photographs include a clock, in which the second hand is not blurred. This indicates that the clock has been photographed as a snapshot, via a separate optical path and superimposed onto the film. The thin line extending to about 284° indicates the

camera shutter closing briefly at the point of film advance, which begins each 3-second exposure.

If the echo *does not* change position in successive photos, then the time interval between the consecutive imaging of the echo is equal to the period of rotation of the radar antenna, or three seconds. If the echo *does* change position in successive photos, then the time interval between the consecutive imaging of the echo will be +/- three seconds, depending on its change of position in relation to the beam sweep. This is particularly the case for the transitions between photos listed in Table 2.

| Transitions entre photos | rotation de l'antenne (°) | Temps écoulé (secondes) |
|---------------------------------|-------------------------------------|--------------------------------|
| 771 et 772 | $360^\circ + 92^\circ = 452^\circ$ | 3,77 s |
| 772 et 773 | $360^\circ - 205^\circ = 155^\circ$ | 1,29 s |
| 773 et 775 | $360^\circ + 309^\circ = 669^\circ$ | 5,58 s |
| 775 et 776 | $360^\circ + 52^\circ = 412^\circ$ | 3,43 s |

Table 2. Time intervals between successive echoes. The intervals for the echo displacements between the remaining photos is 3 seconds. (Column titles: *Transition between photos; Rotation of the antenna; Elapsed time*).

2.7. Orientation and Dimensions of the Radar Echoes

In the following table we have accurately measured the length and width of the echoes in eleven photos, including the degree of orientation, which is the angle of the long axis of the echo in relation to the heading of the B-52.¹³ We can establish the following table for the most important echoes:

¹³ This is illustrated later in 3-9, Figure 42.

| Cliché | Longueur (m) | Largeur (m) | Orientation (deg) |
|---------------|-------------------------|------------------------|------------------------------|
| 771 | 132 | 40 | 8 |
| 772 | 120 | 50 | 17 |
| 773 | 260 (+185 ?) | 113 | 68 |
| 774 | - | - | - |
| 775 | 287 | 105 | 12 |
| 776 | 337 | 76 | 78 |
| 777 | 120 | 36 | 52 |
| 778 | 100 | 63 | 36 |
| 779 | 86 (+309?) | 74 | 77 |
| 780 | 150 | 50 | 51 |
| 781 | 95 | 36 | 17 |
| 782 | 48 | 36 | ? |

Table 3. In this table, orientation is the angle between the long axis of the echo and the heading of the B-52. (Longueur = length; Largeur = width).

The average of the eleven values, without considering the filaments or growths of the echo on certain photos is:

- **Average length = 157 meters**
- **Average width = 62 meters**

However, the resolution of the radar in distance is 30 meters. This means that the edges of a target have an uncertainty of position in the order of +/- 15 meters. A target 30 meters real-

width would be painted on the radarscope as an echo 60 meters wide with blurred edges. As a result, we must reduce the dimensions from the previous average values to the resolution of the radar. We then have:

- **Corrected average length = 127 meters**
- **Corrected Average width = 32 meters**

2.8. Intensity of the Radar Echoes

Another interesting result is obtained by comparing the intensity of the UFO echoes with the intensity of the returned radar signal of the neighboring ground (Sol).

| Cliché | Echo % | Sol % | Echo/Sol % | Distance (nm) |
|---------------|---------------|--------------|-------------------|----------------------|
| 771 | 67 | 91 | 74 | 1,73 |
| 772 | 58 | 91 | 64 | 1,12 |
| 773 | 81 | 91 | 89 | 1,05 |
| 775 | 94 | 89 | 106 | 1,69 |
| 776 | 56 | 90 | 62 | 1,08 |
| 777 | 47 | 84 | 56 | 1,05 |
| 778 | 61 | 78 | 78 | 1,05 |
| 779 | 51 | 80 | 64 | 1,00 |
| 780 | 66 | 80 | 83 | 1,05 |
| 781 | 52 | 90 | 58 | 0,95 |
| 782 | 52 | 90 | 58 | 0,91 |

Table 4. Summary of photometric measurements (from Appendix 1) and the B-52 radar distance to the echo (Sol = ground).

In Table 4 we see an intriguing variation of the echo intensity when the UFO is at a constant distance of 1.05 nm from the B-52. Neither the distance nor the relative positions of the

UFO echo vary in these photos, although the intensity of the radar signal varies considerably from 89% to 56% in pixel saturation. In contrast, the pixel saturation of the most intense ground signal varies less between photos from 91% to 78%. This variation would appear to rule out the possibility of an absorbing cloudy layer interposed between the echo (target) and the radar antenna to explain the variation in the intensity of the UFO echo, since the ground echo-level would also vary accordingly. Consequently, there is an attenuation of the returned radar signal due to other factors.

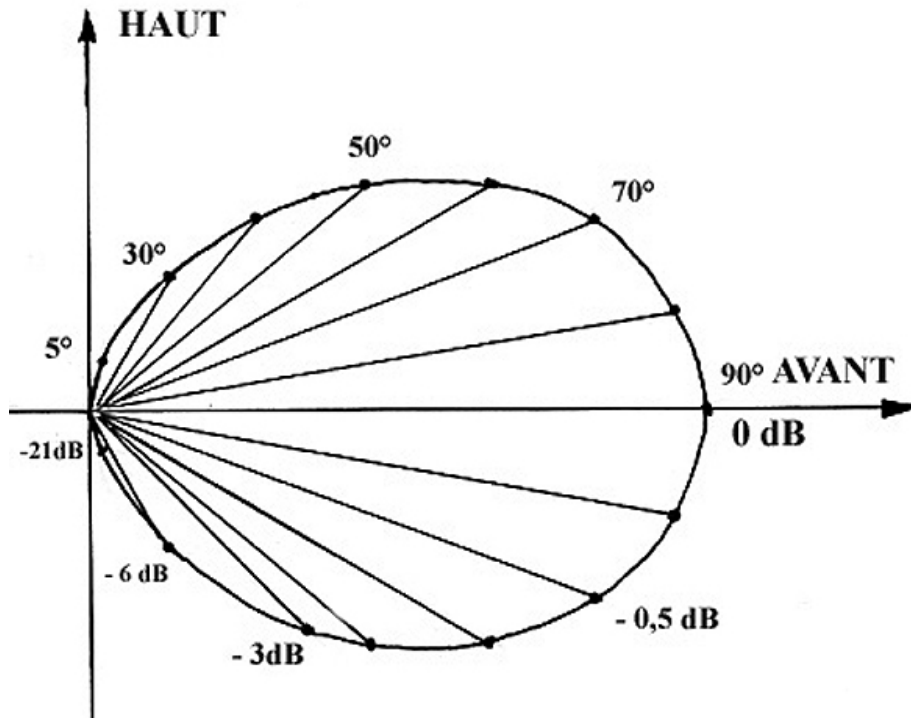

Figure 28. Diagram of the theoretical radiance of the radar antenna in the horizontal plane, assuming that the antenna is not tipped-up relative to its vertical axis of rotation. (Haut = up; Avant = front of the B-52).

One possibility is an attenuation of the transmitted and received signal as a result of the parabolic properties of the radar antenna. This antenna has a narrow radiance diagram in the horizontal plane (in azimuth), in order to acquire a precise angular resolution of a target's position, but in the vertical plane the radiance diagram has a particular shape.

Let us assume for now that the antenna is not tilted either up or down. The radar antenna of the B-52 has a diagram of theoretical radiance that is calculated according to the angle Alpha, existing between the nadir (the vertical point directly below the aircraft) and the direction of the target. The law of variation of the received power is in Cosecant Square of Alpha. This means that the relation between the power emitted in the direction of the axis of the antenna (“AVANT” in Figure 28) and the received power from the direction of the target is the following:

- **Power received in direction Alpha = Cte . Power emitted in direction 90° . [1 / sin² (Alpha)].**

The attenuation is of a factor 132 for an angle Alpha = 5 degrees (21 decibels or dB), and of 4.5 times for Alpha = 28 degrees (6.6 dB), etc. There is an attenuation 1 / sin (Alpha) in the emission of the radar pulse, and the same attenuation in the returned pulse resulting in a total pulse attenuation varying as [1 / sin² (Alpha)]. This effect is simply due to the geometric projection of the radiant surface of the antenna parabola in the direction of the target. This type of antenna design effectively diminishes the attenuation of a ground echo situated directly below the B-52 and increasingly distant from the vertical. This design thus compensates the natural attenuation caused by distance, which varies as the fourth power of the distance for radar receiving a natural echo. Moreover, the ground absorbs the radar wave to some degree and returns only a part of the radar signal towards the aircraft.

The same effect would apply to the UFO accompanying the B-52. However, we cannot infer the location of the UFO in comparison to the horizontal plane of the B-52. What we do know is the distance of the UFO from the B-52 and its azimuth direction from which this distance is measured. As a result, the UFO *can be anywhere in half of a vertical circle* in which the diameter would be the B-52 vertical line. The radius of this circle would be equal to the

distance of the UFO echo and the orientation around the vertical axis corresponding to the azimuth of the echo in the radar photos.

Because the UFO can be anywhere around this half circle, the angle “Alpha” between the direction of the UFO and the nadir can have any value between 0 and ± 90 degrees. We cannot resolve this issue by examining solely one of the eleven photos that feature a clear echo but we have several radar photographs depicting echo variations. Therefore, we can allocate the variations by a modification of the angle alpha, even if the UFO remains at a constant distance. For instance, we can allocate the variations if the UFO is below the aircraft moving vertically, while remaining at a constant distance from the B-52. Let us examine this hypothesis in more detail. Specifically, let us hypothesize that the echo of the UFO is roughly at mid-distance from the ground echo, that is, below the aircraft and somewhat lateral to the left of the B-52.

To examine this hypothesis we have to generate a rough calculation of the attenuation of the radar echo in the direction of the UFO. Although we cannot infer this attenuation, we shall assume further that the reflectivity of the radar waves from the UFO are essentially the same as the ground, which would result in the same returned radar signal for the same distance. In other words, we should observe the same intensity of the echo for the ground and the UFO.

If the UFO is half the distance from the B-52 to the ground, we should see a signal 16 times stronger for the UFO than for the ground ($16 = 2^4$ at the 4th power). Photo 775 provides some support for this hypothesis; in this photo the intensity of the echo of the UFO is superior to that of the ground for a distance that seems comparable. The intensity of the echo of the UFO could also be reduced by a factor of 16 (12 dB) if the UFO was not at the same altitude as the B-52 (direction alpha = 90 degrees when there is no attenuation), but below the horizontal plane of the B-52 at an angle Alpha = 15 degrees, relative to the nadir:

- $\sin(15^\circ) = 0.259$ and $1 / \sin^2(15^\circ) = 14.93$ which is 11.74 dB.

Based on this formula we can calculate the following table:

| Cliché | Echo / Sol | Dis Sol / Dis Echo | Effet Distance | Atten Angle | Alpha |
|--------|------------|--------------------|----------------|-------------|-------|
| 771 | 0,74 | 2.20 / 1,73 | 2,62 | 1 / 3,54 | 32° |
| 772 | 0,64 | 2.13 / 1,12 | 13,08 | 1 / 20,44 | 12,8° |
| 773 | 0,89 | 2.13 / 1,05 | 16,93 | 1 / 19,02 | 13,3° |
| 775 | 1,06 | 2.04 / 1,69 | 2,12 | 1 / 2,00 | 45° |
| 776 | 0,62 | 2.04 / 1,08 | 12,73 | 1 / 20,53 | 12,8° |
| 777 | 0,56 | 1.98 / 1,05 | 12,64 | 1 / 22,57 | 12,2° |
| 778 | 0,78 | 1.97 / 1,05 | 12,39 | 1 / 15,88 | 14,5° |
| 779 | 0,64 | 1.95 / 1,00 | 14,46 | 1 / 25,59 | 11,4° |
| 780 | 0,83 | 1.90 / 1,05 | 10,72 | 1 / 12,92 | 16,2° |
| 781 | 0,58 | 1.87 / 0,95 | 15,01 | 1 / 25,88 | 11,3° |
| 782 | 0,58 | 1.83 / 0,91 | 16,35 | 1 / 28,19 | 10,9° |

Table 5. The column headings are as follows: 1. Photo. 2. Echo/Sol = ratio of the intensity of the UFO and ground echoes by assuming a linear radar and a linear photograph; 3. Dis Sol/Dis Echo = ratio of distances to the edge of the altitude hole / and UFO echo; 4. Effet Distance = ratio of distances to the fourth power; 5. Atten Angle = the attenuation that the angle Alpha must produce to get an echo as bright as in the photographs (second column divided by the fourth column); 6. Alpha = angle of the diagram of radiance (of Figure 28) that allows for the attenuation of the previous column.

We see that this hypothesis leads us to infer that, with the exception of photos 771 and 775, the UFO was below the aircraft at 12.8 degrees on average, or about 0.22 nm (411 meters) from the nadir direction of the antenna. Photo 771 shows that the angle Alpha is 32 degrees, which locates the UFO about 0.92 nm (1700 meters) from the nadir direction of the antenna. In photo 775 it appears that the UFO was at the same altitude as the B-52, provided that its reflectivity was the same as the ground. The hypothesis of a UFO located below the aircraft during the time of the photographs seems fairly appealing. In addition, as we shall see later, this assumption might also explain why photo 774 exhibits no echo, whereas contiguous photos do

show an echo. The hypothetical location of the UFO below the aircraft and comparatively close to the nadir of the antenna would also explain why the ground approach radars at the air base were not able to differentiate the UFO's echo from the echo of the B-52. This hypothesis becomes even more compelling when we consider that the aircraft was equipped with a transponder, which allows a reduction of the attenuation due to the distance (attenuation becomes proportional to the square of the distance instead of the fourth power).

Another interesting fact is that the dimensions of the UFO deduced from photo 775 (246 x 90 meters) are the most probable owing to the very good signal to noise ratio of this photo. However, we need to deduct the resolution in distance of the radar by 37 meters (120 feet). So the probable radar dimensions of the UFO are then in the order of 200 x 50 meters, which is quite large.

Part 3. 2-D Analysis of the Radarscope Photographs

3.1. Displacements and Speeds of the UFO

Although several photos show more than one echo, in the following calculations I will consider only the most intense echoes. Distance will be in nautical miles (1852 meters), speed is given in nm / hour (knots) and converted into km / h, and all speeds are relative to the speed of the B-52 at ~250 knots (460 km/ h, or 285 mph).

- **Photos 771-772.** The position of the UFO echo changes respectively from 1.73 nm at 038 degrees, to 1.12 nm at 244 degrees. This corresponds to a displacement of 2.31 nm in 3.77 seconds, which is an average relative speed of **2205 knots or 4085 km / h (2538 mph).**
- **Photos 772-773.** The position of the UFO echo changes respectively from 1.12 nm at 244 degrees, to 1.05 nm at 039 degrees. This corresponds to a displacement of 2.12 nm in 1.29 seconds, which is an average relative speed of **5916 knots or 10957 km / h (6808 mph).**
- **Photos 773-775.** The position of the UFO echo changes respectively for 1.05 nm at 039 degrees, to 1.69 nm at 348 degrees. This corresponds to a displacement of 1.31 nm in 5.58 seconds, which is an average relative speed of **847 knots or 1569 km / h (975 mph).**
- **Photos 775-776.** The position of the UFO echo changes respectively from 2.13 nm at 348 degrees, to 1.08 nm at 040 degrees. This corresponds to a displacement of 1.69 nm in 3.43 seconds, which is an average relative speed of **1773 knots or 3285 km / h (2041 mph).**

- **Photos 776-778**. No displacement.
- **Photos 778-779**. Displacement towards the right of 0.05 nm in 3 seconds, or a relative speed of **60 knots or 110 km / h (68 mph)**.
- **Photos 779-780**. Displacement towards the left of 0.05 nm in 3 seconds, or relative speed of **60 knots or 110 km / h (68 mph)**.
- **Photos 780-781**. Displacement towards the right of 0.1 nm in 3 seconds, or a relative speed of **120 knots or 220 km / h (136 mph)**.
- **Photos 781-782**. Displacement towards the right of 0.04 nm in 3 seconds, or a relative speed of **48 knots or 90 km / h (56 mph)**.
- **Photo 783**. The UFO echo disappears in less than 3 seconds.

3.2. The B-52 Altitude and Descent Slope

All radarscope photographs display a central region referred to as the altitude hole, which is related to the altitude of the B-52. A comparison of the altitude hole diameters in successive photos shows that the radius progressively decreases. This verifies that the B-52 was descending in altitude.

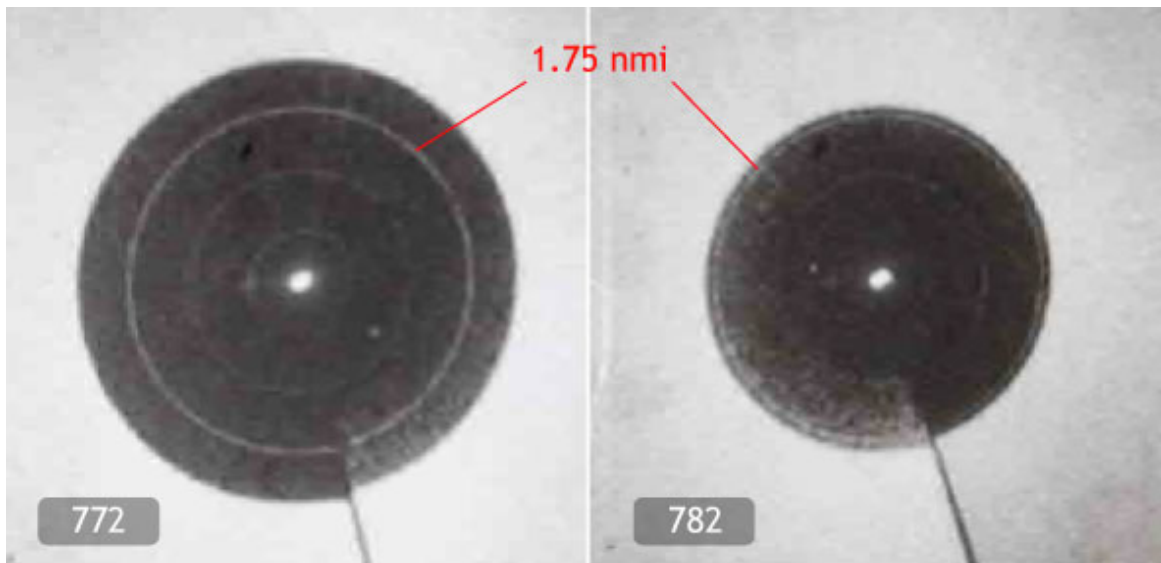

| Numéro de la photo | Rayon du trou d'altitude en pixels (Echelle : pix/nm) | Rayon en miles nautiques |
|--------------------|-------------------------------------------------------|--------------------------|
| 771 | 268 (140) | 2,20 |
| 772 | 264 (146) | 2,13 |
| 773 | 270 (150) | 2,13 |
| 774 | 253 (148) | 2,06 |
| 775 | 259 (144) | 2,04 |
| 776 | 257 (146) | 2,04 |
| 777 | 250 (154) | 1,98 |
| 778 | 245 (148) | 1,97 |
| 779 | 243 (150) | 1,95 |
| 780 | 230 (144) | 1,90 |
| 781 | 235 (156) | 1,87 |
| 782 | 225 (154) | 1,83 |
| 783 | 221 (150) | 1,82 |
| 784 | 212 (150?) | 1,79 |

Table 5. Radius of the altitude hole in pixels and in nautical miles. Distances are calibrated to the range ring visible in all photos at 1.75 nm. (Echelle = Scale).

While cruising at FL 200 (Flight Level 20,000 feet altitude, or 6100 meters), the B-52's altimeter would be set to the standard pressure of 29.92 inches of mercury (1013.25 hectopascals). All aircraft at flight level set their altimeters to the same standard pressure, and the ground controllers allocate different flight levels to aircraft in order to avoid collisions due to altimeter-setting errors. According to the Blue Book documents, the B-52 descended from FL 200 down to the altitude of the Minot runway, which is 1723 feet above Mean Sea Level (MSL). On reaching FL 180 (18,000 feet), procedure required the pilot to adjust the altimeter from the standard pressure to the local MSL atmospheric pressure setting, in order to assure accurate altitudes above the ground. In this instance, according to the transcription of communications

between RAPCON and the B-52, at 4:09 a.m. (CDT) this corresponded to 30.12 inches of mercury (1019.77 hectopascals).¹⁴

The change in the altimeter pressure setting of 6.52 hectopascals corresponds to a reduction of the indicated altitude by 190 feet (58 meters). Although the difference is essentially negligible to our calculations, the B-52 actually began its descent at a true altitude of 19810 feet MSL.

For purposes of our study, let us assume that the distance to the edge of the altitude hole in the photos is equal to the B-52 altitude. Table 5 shows that the altitude for photo 771 (at 9:06:14Z) is 2.20 nm, and for photo 782 (at 9:06:51) is 1.82 nm. The time interval between photos is 37 seconds, and the reduction of the altitude hole radius is 0.38 nm (equal to 2307 feet). As a result, the reduction of the altitude hole radius for one minute would be 3742 feet.

Minot AFB, Operations Division chief Colonel Arthur Werlich, who was also a B-52 pilot and responsible for the UFO investigation, provided the speed of the B-52 during its descent in the Basic Reporting Data:

C. MANNER OF OBSERVATION: (1) GROUND-VISUAL, AND AIR ELECTRONICS (ASQ-38 IN STATION KEEPING MODE). (2) NO OPTICAL AIDS USED. (3) B-52H, JAG31. ELECTRONIC SIGHTING DATA: FL200 TO APPROXIMATELY 9,000 FEET, 116 DEGREES MH, 280-230 IAS, MINOT AFB: VISUAL SIGHTING DATA: 3200 FEET MSL, 335 DEGREES MH, APPROXIMATELY 180 IAS.¹⁵

The B-52's indicated air speed during descent ranged from 280 to 230 nm / h (knots; kt), or an average speed of 250 kt, which would require 14.4 seconds for the B-52 to travel a distance

¹⁴ In the Basic Reporting Data, Werlich provides the altimeter settings for: "0255 CDT - 30.14 inches," "0355 CDT - 30.12 inches," and "0455 CDT - 30.11 inches" (3-4). The altimeter setting is a computed value of MSL pressure based on the International Civil Aviation Organization (ICAO) standard atmosphere expressed in hundredths of inches of mercury, which is used to set the sub-scale of an altimeter so the height scale indicates the pressure altitude of the instrument above MSL.

¹⁵ Basic Reporting Data and Format [Teletype], 290428Z OCT 68, *SUBJ: UFO REPORT*, 2. Available from: http://www.minotb52ufo.com/pdf/Basic_Reporting_Data.pdf.

of one nautical mile. During the 37 seconds that were captured by the photographs, the B-52 traveled a distance that ranged from 2.36 to 2.88 nm, or an average distance of about 2.57 nm.

If the radius of the altitude hole were equal to the altitude of the B-52 above the ground, then the aircraft would have traveled between 2.36 and 2.88 nm while descending 0.38 nm. This corresponds to a descent slope of:

- $\text{Arctg}(0.38 / 2.36 \text{ or } 2.88) = 9.1^\circ \text{ and } 7.5^\circ \text{ respectively.}$

Let us examine the transcription of communications between Radar Approach Control (RAPCON) and the B-52 aircraft at the moment when communications resumed following the VHF radio transmission failure.

Page 2

ot 31 roger request radio check on 271.3 then return this frequency again
ao 271.3
0903 ct JAG 31 how do you hear this transmitter
ac You're loud and clear how me
ct You're loud and clear also
ac O.K. I'll stay on this frequency?
ot Affirmative I was wondering how far out did you see that UFO?
0904 ac He was about $1\frac{1}{2}$ miles off our left wing at 35 miles when we started in and
he stayed with us 'til about 10
ot I wonder if that could have been your radio troubles
ac I don't know.... but that's exactly when they started
ot Roger
ot 31 Cleared for low approach report missed approach
ac 31 roger

Figure 29. Radio communications between 4:03 and 4:04 a.m. (CDT). Communications resumed with the B-52 after the UFO disappeared from the radar after 4:02. [ct =controller; ac = aircraft (JAG 31)].

According to the documents, the B-52 was at an altitude of 19810 feet MSL, at a distance of 35 nm from the Deering TACAN transmitter (situated adjacent to the runway at 37% of the length from the northwest end). If the B-52 descended 2307 feet each time and moved forward

2.36 or 2.88 nm at an altitude equal to the MSL altitude of the runway at 1723 feet, the distance traveled would have been:

- **2.36 or 2.88 (19810 — 1723) / 2307 = 18.50 and 22.58 nm.**

If the beginning of the descent of the B-52 had been 35 nm from the TACAN, it would have touched the ground at either 16.5 or 12.42 nm ahead of the runway (30.6 or 23 km). Because this is not possible, the actual rate of descent had to be much less than that, which also means that the radius of the altitude hole is *not* equal to the B-52 altitude. As a result, a constant corrective factor must be applied, which takes into account that the radar antenna had to be tilted upwards from its horizontal axis in keeping with information in the technical manual for Station Keep mode. We can determine the order of magnitude of the corrective factor, which is the cosine of the angle of incline (Tilt) of the antenna radar. In order to do that, let us write equations for photos 771 and 783. Our variables are as follows:

- **Tilt = tilt-up angle of the radar antenna. Tilt is also the half of the top angle of the blind cone of the radar centered on the nadir of the B-52.**
- **K = Cos (Tilt)**
- **Alt771 = ground altitude of the B-52 during photo 771 in nautical miles.**
- **Alt783 = ground altitude of the B-52 during photo 783 in nautical miles (1 nm = 1852 m or 6072 feet).**

Therefore,

$$\text{Alt771} = 2.20 \text{ K} \quad (1)$$

$$\text{Alt783} = 1.82 \text{ K} \quad (2)$$

Next, let us examine the descent slope of the B-52 within strict limits while keeping in mind that certain parameters are still not accurately known. The speed of the B-52 must be between 280 and 230 knots, which corresponds to a traveled distance between 2.364 and 2.878 nm over the course of 37 seconds. The beginning of descent must be located 35 nm from the position of the TACAN adjacent to the runway. The end of descent must be at the distance prescribed by the Instrument Approach Procedures in the 2003 *Terminal Procedures* (approach plates) for Minot AFB. Which is either at the Outer Marker located at 14 nm from the Deering TACAN at an altitude of 3500 feet MSL, or at the Final Approach Fix (Middle Marker) located at 6.3 nm from the TACAN at 3200 feet MSL. As a result, the slope of the smallest descent rate corresponds to a traveled distance of:

- **35 - 6.3 = 28.7 nm.**

The slope of the largest descent rate corresponds to a traveled distance of:

- **35 - 14 = 21 nm.**

The loss of altitude of the slope of the smallest possible descent rate corresponds to:

- **19810 - 3200 = 16610 feet or 2.736 nm.**

The loss of altitude of the slope of the largest possible descent rate corresponds to:

- **19810 - 3500 = 16310 feet or 2.686 nm.**

Thus, the slope of the *smallest* possible descent rate is:

- **2.736 nm / 28.7 nm = 0.095331 (or an angle of 5.44°).**

The slope of the *largest* possible descent rate is:

- **2.686 nm / 21 nm = 0.1279048 (or an angle of 7.3°).**

Naturally, the smaller slope corresponds to a lesser speed, whereas the larger slope corresponds to a higher speed.

Let us call:

- **Dis771 = the distance traveled since the beginning of descent at the time of photo 771 expressed in nm.**
- **Dis783 = the distance traveled since the beginning of descent at the time of photo 783 expressed in nm.**

If the MSL altitude of Minot AFB is 1723 feet or 0.284 nm, and if 19810 feet corresponds to 3.2625 nm, then the slope of the smallest possible descent rate (departure at 35 nm from the Deering TACAN) is:

$$\mathbf{Dis783 - Dis771 = 2.364 \text{ nm} \quad (3)}$$

$$\mathbf{Alt771 + 0.284 = 3.2625 - 0.1028571 \text{ Dis771} \quad (4)}$$

$$\mathbf{Alt783 + 0.284 = 3.2625 - 0.095331 (\text{Dis771} + 2.364) \quad (5)}$$

$$\mathbf{Alt783 + 0.284 = Alt771 + 0.284 - 0.2431542 \text{ nm} = \text{Alt } 771 + 0.284 - 1476 \text{ feet.} \quad (6)}$$

The slope of the largest possible descent rate (departure at 35 nm from TACAN) is:

$$\mathbf{Dis783 - Dis771 = 2.878 \text{ nm} \quad (7)}$$

$$\mathbf{Alt771 + 0.284 = 3.2625 - 0.1279048 \text{ Dis771} \quad (8)}$$

$$\mathbf{Alt783 + 0.284 = 3.2625 - 0.1279048 (\text{Dis771} + 2.878) \quad (9)}$$

$$\mathbf{Alt783 + 0.284 = Alt771 + 0.284 - 0.36811 \text{ nm} = \text{Alt } 771 + 0.284 - 2235 \text{ feet.} \quad (10)}$$

In any case, according to (1) and (2) we have:

$$\text{Alt783} / \text{Alt771} = 1.82 / 2.20 = 0.8272727 \quad (11)$$

$$\text{Alt783} = 0.8272727 \text{ Alt771}. \quad (12)$$

Regarding the slope of the smallest possible descent rate (departure at 35 nm from the TACAN) we have the following:

$$\text{Alt783} = \text{Alt771} - 0.2431542 \text{ nm} = 0.8272727 \text{ Alt771} \quad (13)$$

$$\text{Alt771} = 1.4077346 \text{ nm} = 8548 \text{ feet} \quad (14)$$

$$\text{Alt783} = 7071 \text{ feet}. \quad (15)$$

And, according to (4):

$$\text{Alt771} + 0.284 = 3.2625 - 0.095331 \text{ Dis771}. \quad (4)$$

Consequently,

$$\text{Dis771} = 15.27 \text{ nm} \quad (16)$$

$$\text{Dis783} = 15.27 \text{ nm} + 2.364 = 17.64 \text{ nm}. \quad (16 \text{ bis})$$

For this hypothesis the distance of photo 783 from the TACAN would be:

$$\text{Distance 783 from TACAN} = 35 - 17.64 = 17.36 \text{ nm}. \quad (16 \text{ ter})$$

As a result, the smallest descent slope is compatible with the radarscope photographs.

If we consider the slope with the largest possible descent (departure at 35 nm from the TACAN), we have the following:

$$\text{Alt783} = \text{Alt771} - 0.36811 \text{ nm} = 0.8272727 \text{ Alt771} \quad (17)$$

$$\text{Alt771} = 2.13116 \text{ nm} = 12940 \text{ feet} \quad (18)$$

$$\text{Alt783} = 17631 \text{ nm} = 10705 \text{ feet}. \quad (19)$$

According to (8):

$$\text{Alt771} + 0.284 = 3.2625 - 0.1279048 \text{ Dis771}. \quad (8)$$

Consequently,

$$\text{Dis771} = 9.50 \text{ nm} \quad (20)$$

$$\text{Dis783} = 9.50 \text{ nm} + 2.878 = 12.38 \text{ nm}. \quad (20 \text{ bis})$$

For this hypothesis the distance of photo 783 from the TACAN would be:

$$\text{Distance 783 from TACAN} = 35 - 12.38 = 22.62 \text{ nm}. \quad (20 \text{ ter})$$

As a result, the largest descent slope is also compatible with the radarscope photographs.

3.3. The B-52 Approach Speed and Descent Slope

Using two extreme speeds of the B-52 at 280 and 230 knots, we have concluded that the smallest and largest descent slopes are compatible with radar photographs. But what would happen if we consider an averaged speed of 250 knots, while keeping the largest slope? For this hypothesis the 37-second distance traveled during the radar photographs would have been 2.57 nm. We then calculate:

$$\text{Dis783} - \text{Dis771} = 2.57 \text{ nm} \quad (21)$$

$$\text{Alt771} + 0,284 = 3.2625 - 0.1279048 \text{ Dis771} \quad (22)$$

$$\text{Alt783} + 0.284 = 3.2625 - 0.1279048 (\text{Dis771} + 2.57) \quad (23)$$

$$\text{Alt783} = \text{Alt771} - 0.3287 \text{ nm} = \text{Alt 771} - 1996 \text{ feet} \quad (24)$$

$$\text{Alt783} = 0.8272727 \text{ Alt771} \quad (12)$$

$$\text{Alt783} = \text{Alt771} - 0.3287 \text{ nm} = 0.8272727 \text{ Alt771} \quad (25)$$

$$\text{Alt771} = 1.903 \text{ nm} = 11555 \text{ feet} \quad (26)$$

$$\text{Alt783} = 1.5743 \text{ nm} = 9559 \text{ feet.} \quad (27)$$

According to (22):

$$\text{Dis771} = 8.409 \text{ nm} \quad (28)$$

$$\text{Dis783} = 8.409 \text{ nm} + 2.57 \text{ nm} = 10.98 \text{ nm.} \quad (29)$$

For this hypothesis the distance of photo 783 from TACAN would be:

$$\text{Distance 783 from TACAN} = 35 - 10.98 = 24.02 \text{ nm.} \quad (30)$$

As can be seen, the largest descent slope and an average speed of 250 knots are compatible with the radarscope photographs. Note that the reduction of the speed of the B-52 by 30 knots moves photo 783 away from the TACAN by 1.40 nm. Could we refine the speed and the position of the B-52 during the photographs by drawing on other physical evidence?

3.4. Refining the B-52 Position With Terrain Features

Photo 783 is the only photo in the series that shows the apparent details of a large ground feature. The lack of terrain features in the other photos is normal because the region is relatively flat, and mostly farm fields with few topographical details. This feature is located near the 5 nm (9.26 km) range limit of the radar mode and is quite large, since the distance between the heading markers (7 and 8) is one nautical mile (1852 m). It appears to be a body of water, which returns less of the radar signal than the surrounding terrain. Here is what we can see in the upper left corner of photo 783:

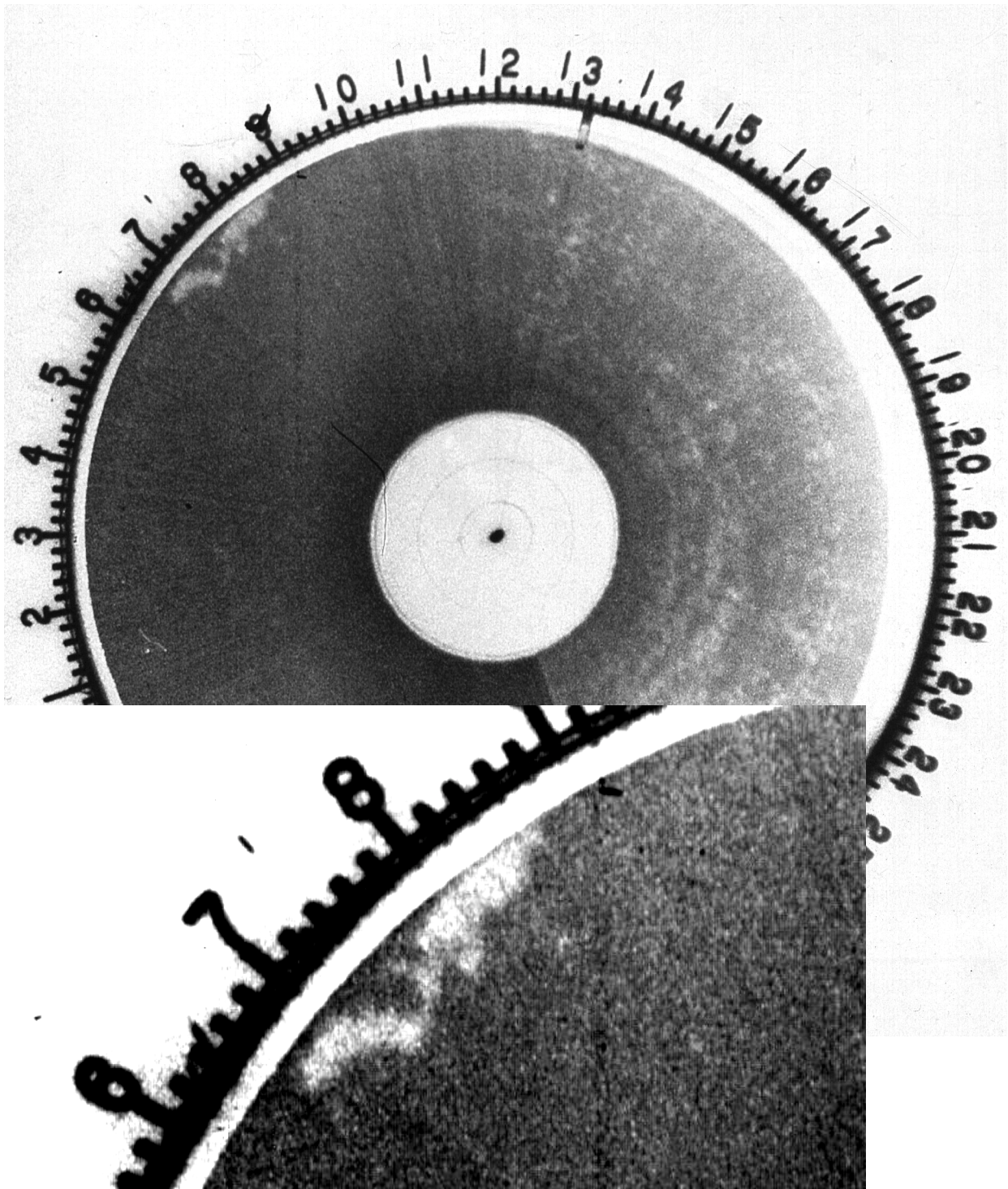

Figure 30. Radarscope photo 783, with inset of the upper left edge of the display. This is a negative image, in which white corresponds to a lesser amount of returned radar microwave energy. The feature is quite large at about 2 nm in length.

In order to properly orient the feature to a map of the region, we can rotate the photo to the true course of the B-52 at 122 degrees. The resulting image is a 50% transparency with a change of scale in order to superimpose the photo on the map in Figure 6.



Figure 31. Figure 30 superimposed on the map in Figure 6, with a 122° clock-wise rotation and correction of the scale (cross rulings are in statute miles).

The apparent watercourse seems to correspond to a section of Lake Darling, ND, located just west of the missile Launch Facility N-7, and the small rural town of Grano, ND. The B-52 radar seems to paint the west bank of the lake. Let us consult a more detailed topographical map.

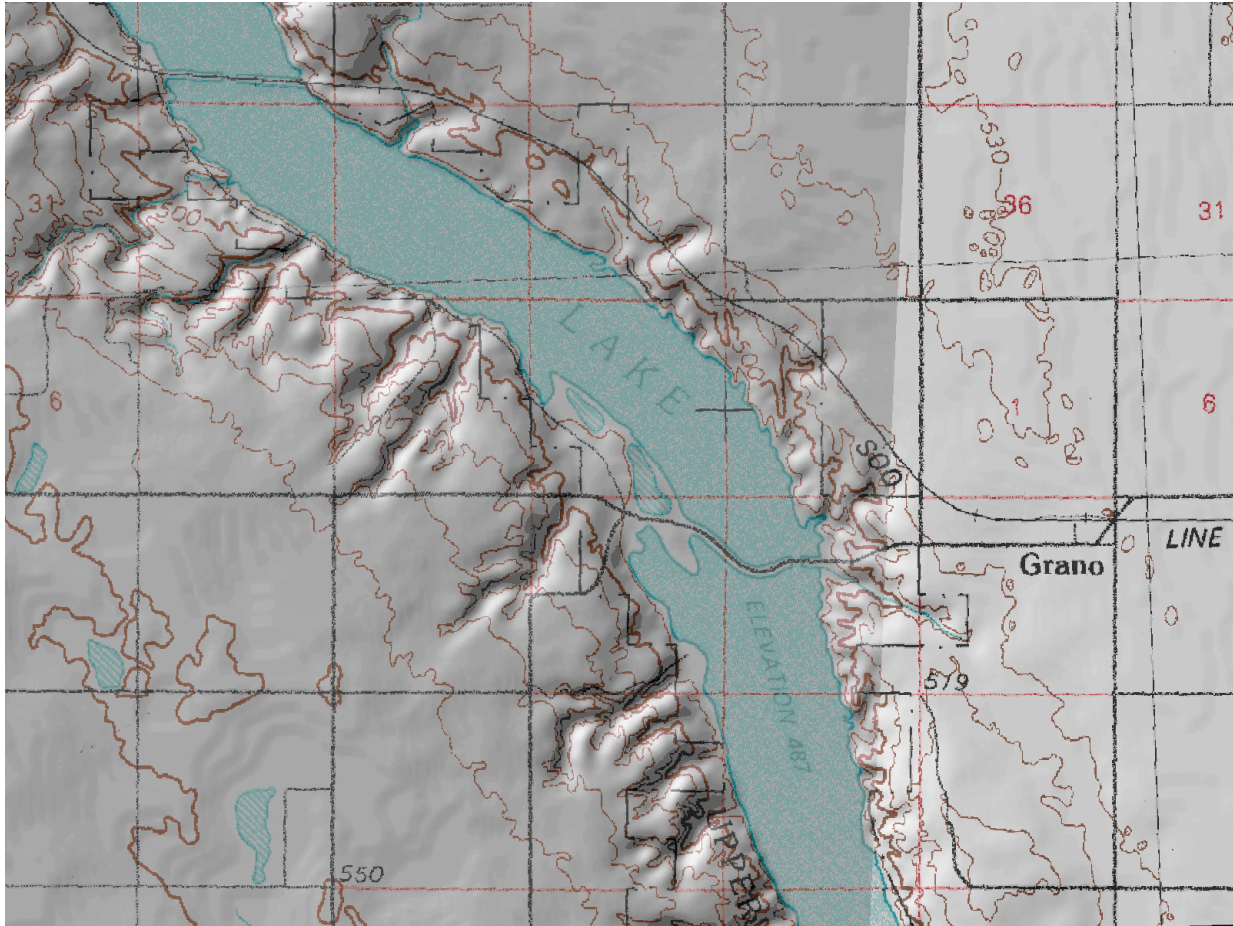

Figure 32. Topographical map of Lake Darling. Cross-rulings are in statute miles (1609 meters) with north at the top. (Source: www.tralis.com).

On this topographical map the narrowing contour lines reveal that elevations adjacent to the shoreline of the lake are comparatively abrupt. Considering that photo 783 was acquired at a distance of ~ 4.3 nm and a ground altitude of ~1.3 nm, the viewing angle would be 16.6 degrees. It is conceivable that at this limited perspective the west shore would be somewhat concealed from the radar, though the characteristic peninsulas within the hooked-bays in the center of the

map is rather clear. To understand more clearly what the radar has captured, let us consult a satellite photograph of this section of Lake Darling, ND.



Figure 33. Satellite image west of Grano, ND. Lake Darling is part of the Upper Souris National Wildlife Refuge, established in 1935 as a refuge and breeding ground for migratory birds and other wildlife. The length of the peninsula within the hooked-bays is 1.09 nm, according to the map in Figure 32.

Map source: <http://maps.google.com/?ie=UTF8&t=f&ecpose=48.62011215,-101.60178955,981.84,-0.112,27.171,0&ll=48.622214,-101.601796&spn=0.003915,0.007902&z=18>.

On the satellite photograph we clearly see the shoreline and roads, as well as drainage flows along the elevated terrain adjacent to the lake. At the time of the radarscope photos, the B-52 would have been situated in the west-northwest to west direction at roughly 7-4 nm. If we convert the scale and orientation of photo 783 and superimpose it on the satellite photograph we get the following:

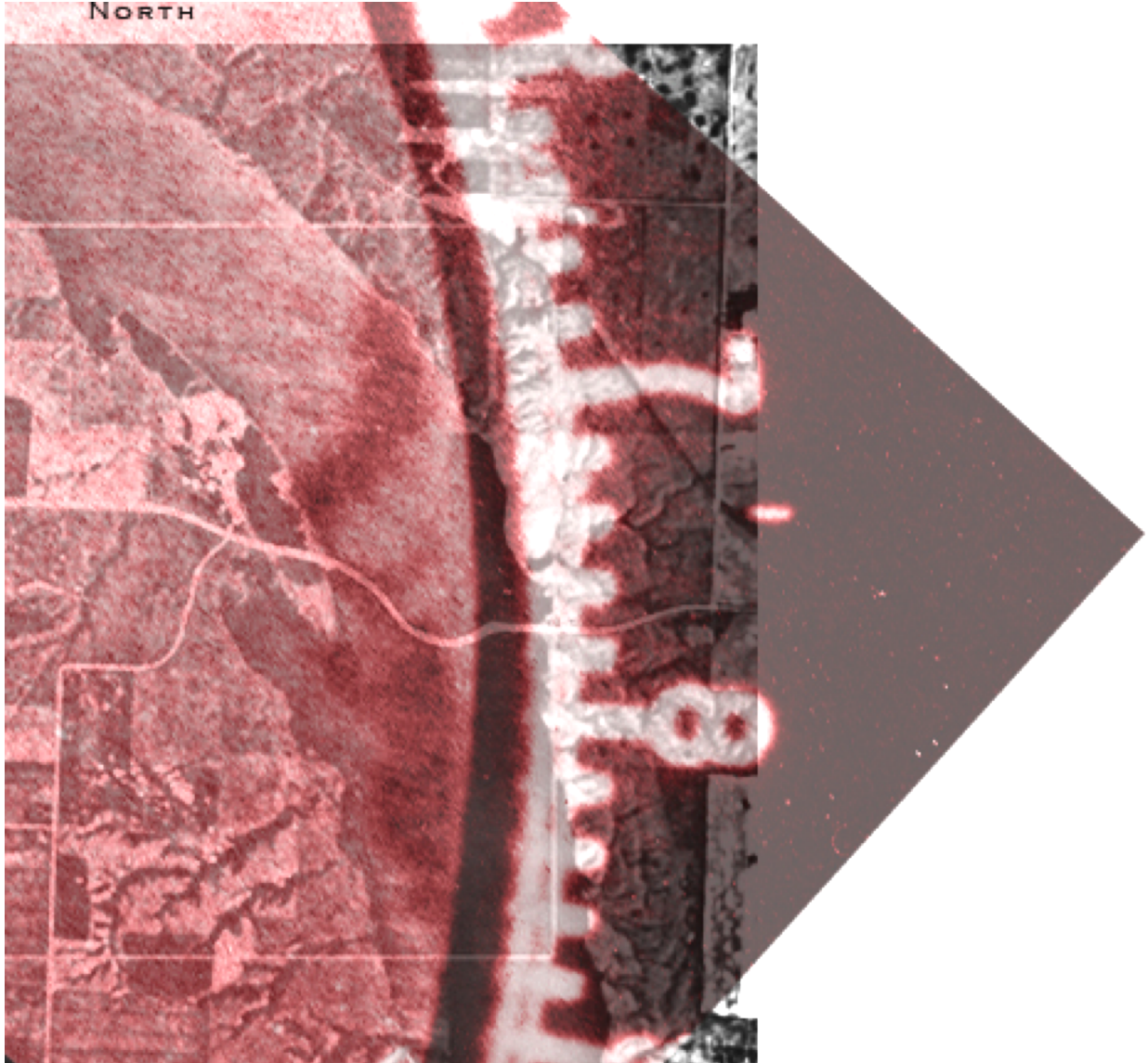

Figure 34. Superimposition of photo 783 (positive image) and satellite image with the same scale and orientation.

Properly scaled and oriented to the true heading of the B-52, when we place the B-52 on the flight track we see that the curves of the shoreline of Lake Darling correspond to those of the dark terrain features on the periphery of radarscope photo 783. In fact, several details of the radar image of the lake correspond extremely well to those of the satellite photograph as indicated in Figure 35.

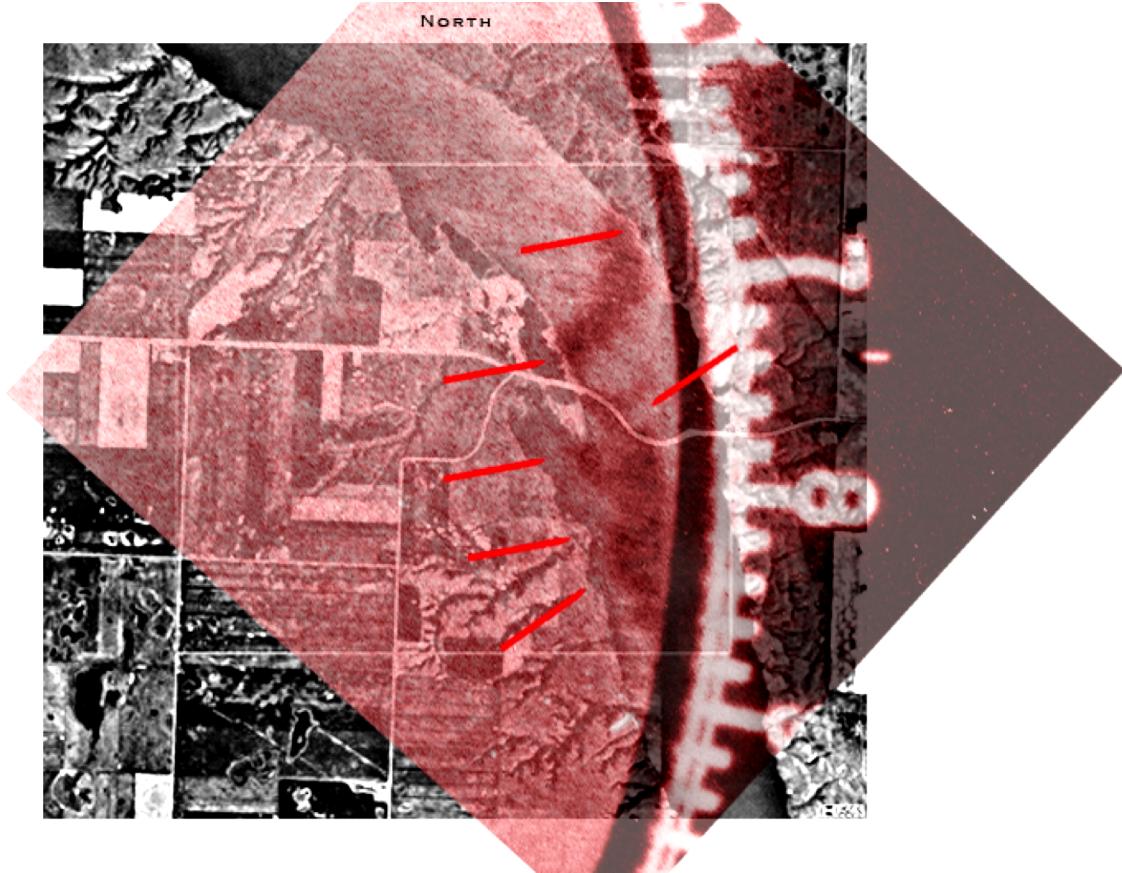

Figure 35. Features that correspond in both the radar photo and aerial photograph.

Based on these maps, we can accurately determine the location of the B-52 at the precise time of photo 783, by measuring the pixel distance and the direction of the southern end of the peninsula within the hooked-bays. The distance of the B-52 in the photo is 4.658 nm at 078 degrees, although this result is an inclined distance measured from an altitude of 1.763 nm above the ground. Consequently, it is necessary to use Pythagoras' theorem to calculate the distance measured on the ground:

$$\text{(Ground Distance)}^2 = (4.658)^2 - (1.763)^2 \quad (31)$$

$$\text{Ground Distance \#783} = 4.31 \text{ nm} \quad (31 \text{ bis})$$

Accordingly, the ground distance from the B-52 to the south hooked-bay within the elbow of the lake is 4.31 nm at azimuth 258 degrees. When we draw this direction and distance on the USGS map we find that the coordinates are located precisely on the straight B-52 TACAN approach trajectory extending from the WT fix to the runway at Minot AFB. We now have an independent verification that the B-52 was on the correct descent trajectory to Minot AFB. In addition, we now know the precise location of the B-52 at 09:06:51Z, in relation to the Deering TACAN located adjacent to the runway at Minot AFB:

- **TACAN distance = 18.8 nm (34.8 km) at 306° true.**

The B-52 was in fact 16.2 nm (30.0 km) away from the WT fix, where it began the descent following a standard 180° turnaround. This position is drawn on the map of Figure 36.

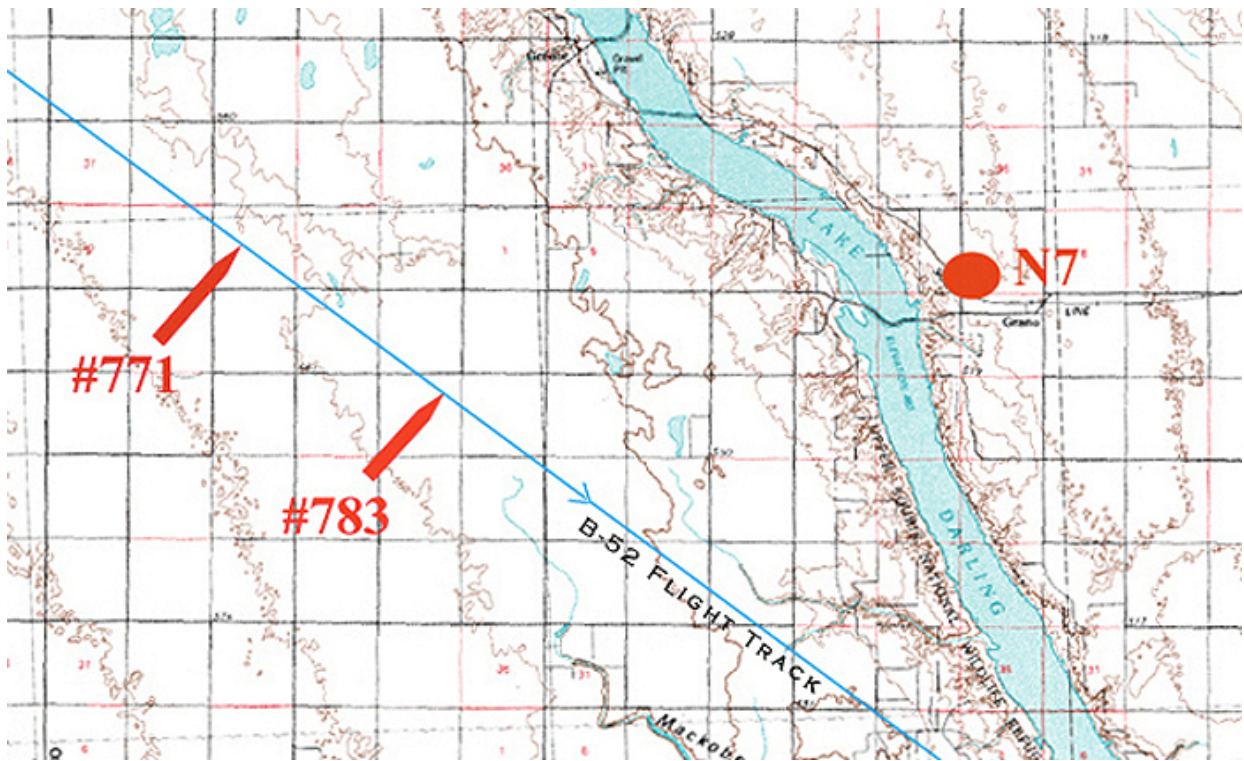

Figure 36. Position of the B-52 during radarscope photo 771 and 783.

3.5. Refining the B-52 Speed Between Photos 782 and 783

Unfortunately, none of the other photos reveal easily identifiable details of the terrain. However, since the B-52 heading is toward the top of the photos and the ground is moving downwards, we can attempt to discern the lake in photo 782. By significantly forcing the contrast and brightness of the positive image, it is possible to differentiate what appear to be details of the lake near the same heading markers (7 and 8).

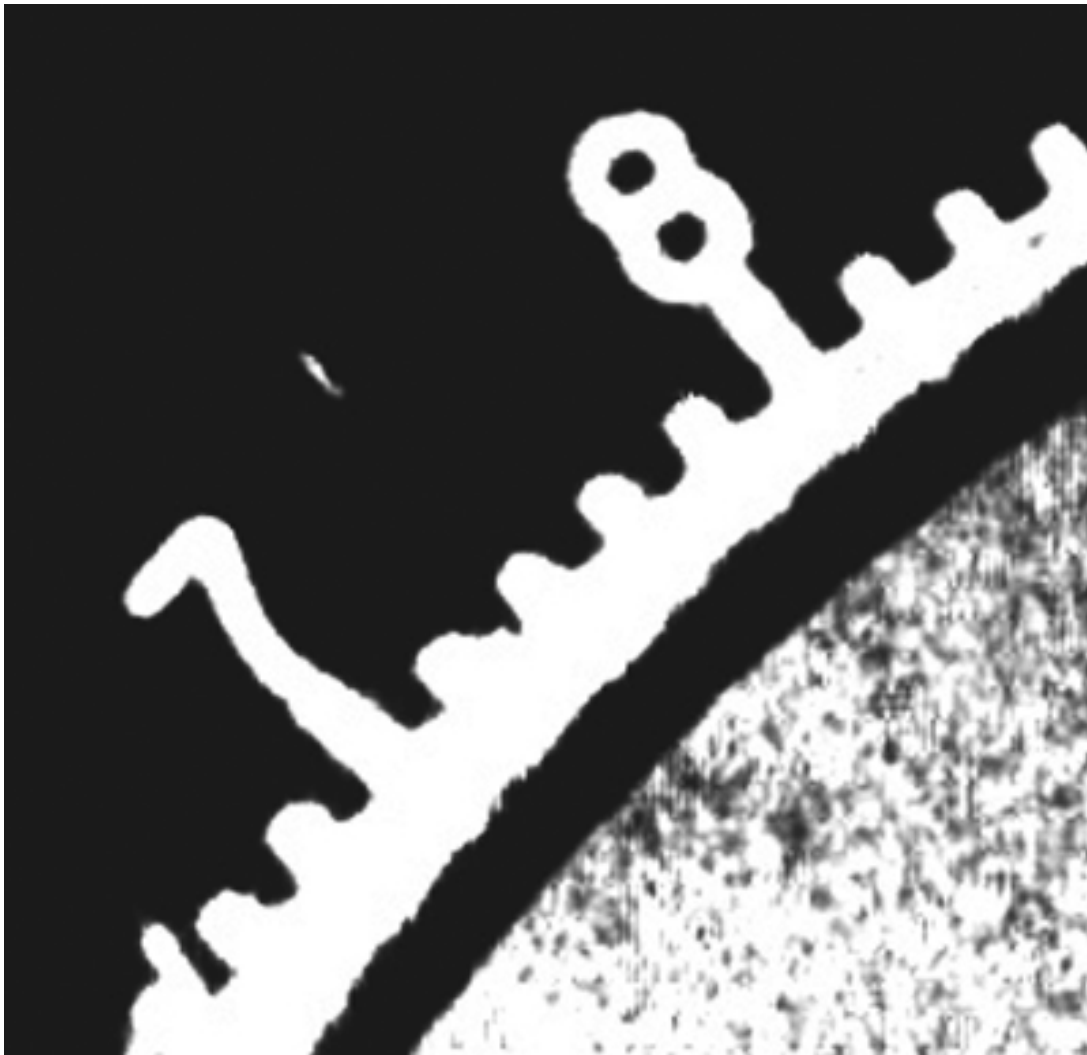

Figure 37. The upper left edge of photo 782.

These blurred stains are definitely present, though only slightly above the *radar noise* of the ground. To determine whether photos 782 and 783 correlate, we shall make use of specialized software in order to examine the photos at the level of pixels. We find that both photos contain a *blurred peak*, which indicates a vertical displacement of 0.211 nm between the two photos. However, since photo 782 is very noisy this maximum is not very accurate.

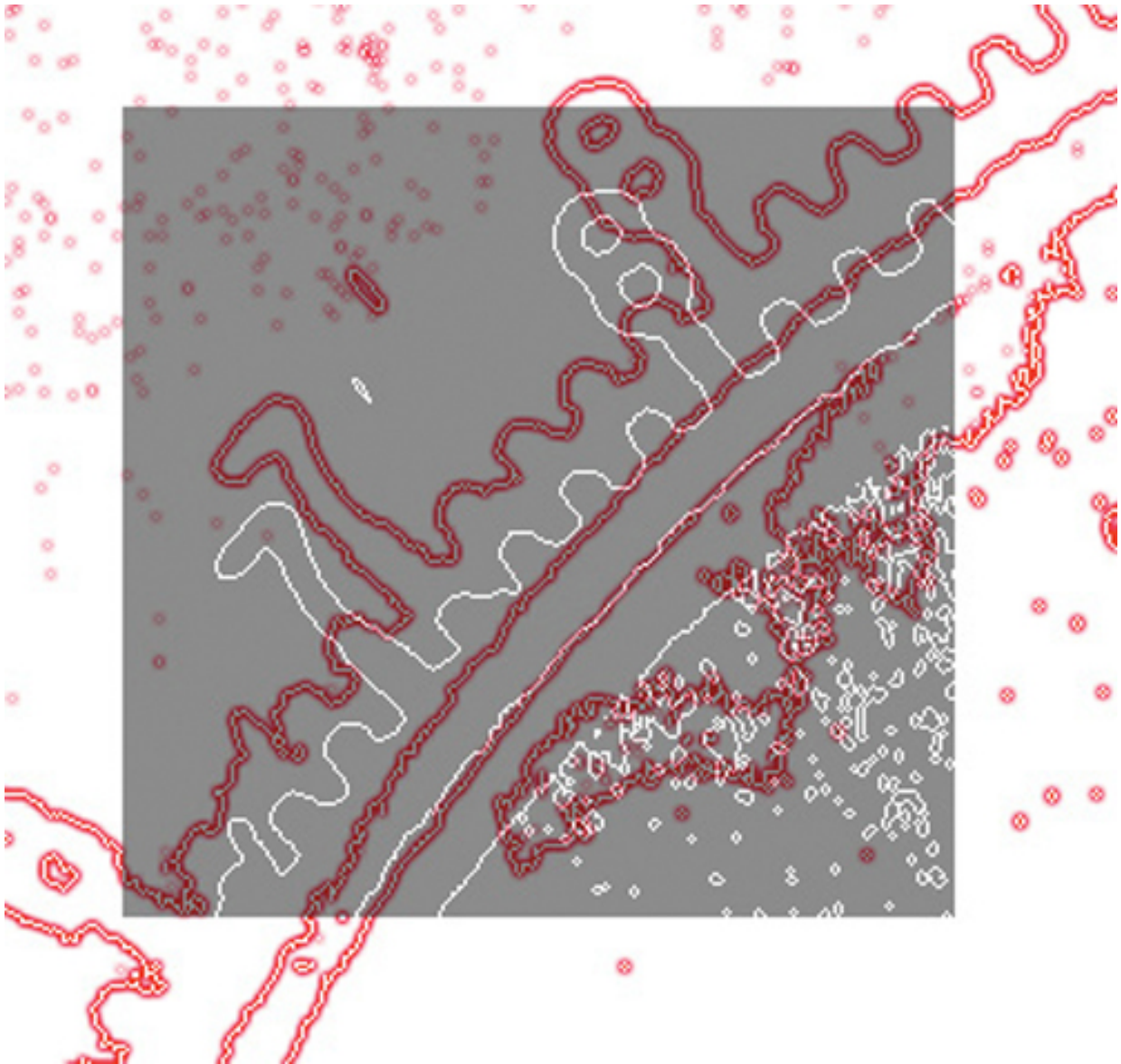

Figure 38. Superimposition of the contour lines of photos 782 (in white) and 783 (in red). The displacement is 33 pixels, which is 0.212 nm.

It would appear that the B-52 moved 0.211 nm during 2.98 seconds (rather than 3 seconds, since the rotation of the antenna is 2 degrees less in azimuth), and the speed of B-52 was 254 knots (470 km / h). For a B-52 in descent this speed is quite reasonable, even though the measurement might not be very reliable due to the poor resolution of the lake feature in photo 782.

3.6. Positions of the B-52 During Photos 771 to 783

The radarscope photos were taken over a total period of 37.5 seconds (photo 771 at 1.5 seconds, and 12 photos at 3 seconds each), and the extreme indications of the clock are also equal to a period of 37.5 seconds (09:06:14—09:06:51.5Z = 37.5 seconds). Therefore, the B-52 traveled 2.65 nm at the previously measured speed. The two extreme positions in relation to the Deering TACAN are:

- **Photo 783: 306° at 18.8 nm**
- **Photo 771: 306° at 18.8 + 2.65 = 21.45 nm.**

We observe that the first radarscope photo (771) was exposed directly west of the missile Launch Facility November-7, at a distance of 7.65 nm (14.2 km). In relation to the WT fix, the B-52 was therefore:

- **Photo 783: 126° at 16.2 nm**
- **Photo 771: 126° at 13.55 nm.**

Assuming a constant speed of 254 knots, at the beginning of the photos (771), the B-52 was in flight for 3.2 minutes after having passed directly over the WT fix, and had a remaining 5.07 minutes of flight before passing over the Deering TACAN transmitter.



Figure 39. The extreme positions of the B-52 during the radarscope photos. Photo 783 has been rotated to the true course of the B-52 at 122 degrees on approach to the runway, and scaled to match the underlying USGS map with Werlich Overlay, and satellite image of Lake Darling. The B-52 covered 2.65 nm over the course of the photos, and was 18.8 nm from the TACAN at the most probable altitude of 8865 feet MSL during 783. (USGS map with Werlich Overlay available from: http://www.minotb52ufo.com/mapsnew/usgs_poher.php).

What is readily apparent is that the position indicated by Col. Werlich is *entirely incompatible* with the direction and distance to the shorelines of Lake Darling, as well as the altitude of the B-52 at the time of the photos.

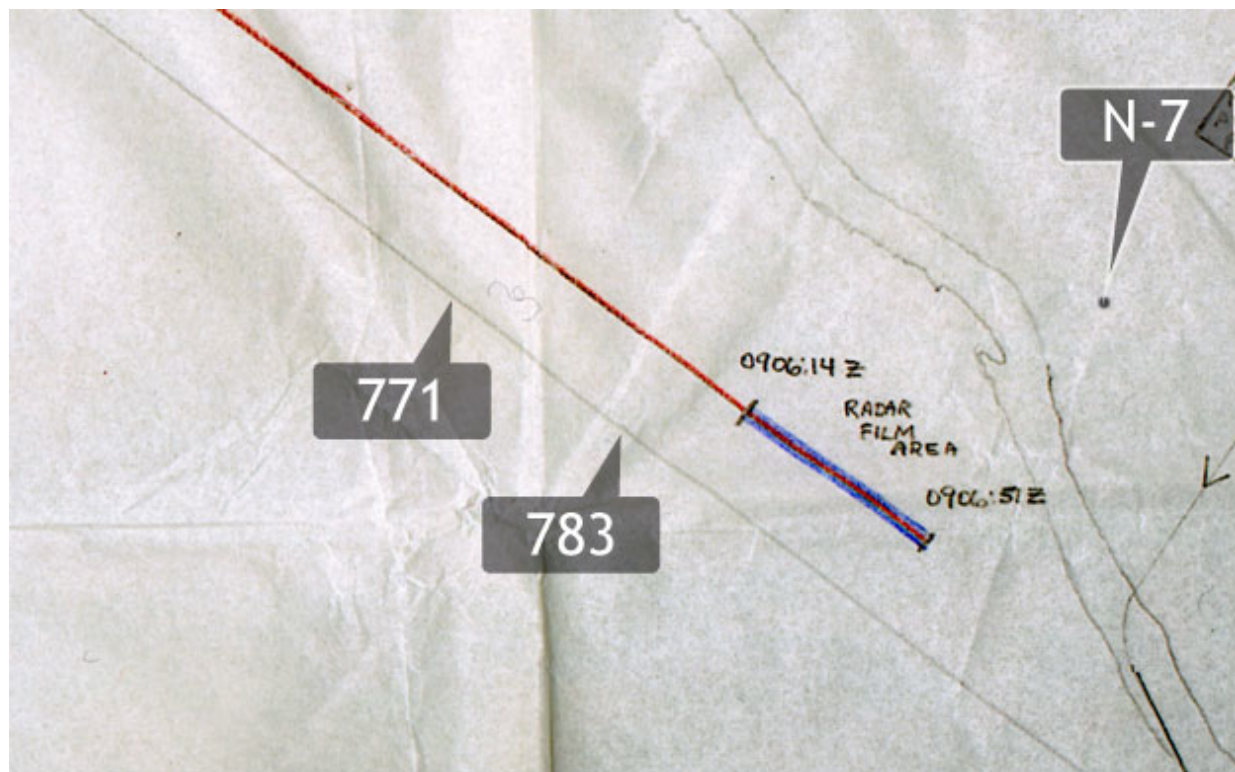

Figure 40. Real position of the B-52 during the radarscope photo sequence compared to Werlich's "Radar Film Area" drawn on his Overlay Map. He states in the Basic Reporting Data that the "RADAR ECHO ACCOMPANIED AIRCRAFT TO APPROX. 14 NAUTICAL MILES, 296 RADIAL, APPROX. 9000 FEET MSL." (3).

3.7. 2-D Positions of the UFO in Relation to the B-52

It is possible to illustrate to scale the successive positions of the echo in relation to the B-52 along its trajectory. Because the radar measures only distance and azimuth, we cannot determine the *true* altitude of the UFO. Consequently, in Figure 41 we assume that the UFO and B-52 were at co-altitudes. In the more probable hypothesis that the UFO was beneath the B-52, the following figure depicts a UFO trajectory that is too extensive by a factor we will be calculating later. Whereas the azimuths between the UFO and the B-52 would remain consistent, the distance would vary depending on the altitude angle (slant range) of the UFO below the altitude of the B-52. Consequently, it would be necessary to generate a slight anamorphous effect in order to illustrate the trajectory from this perspective.

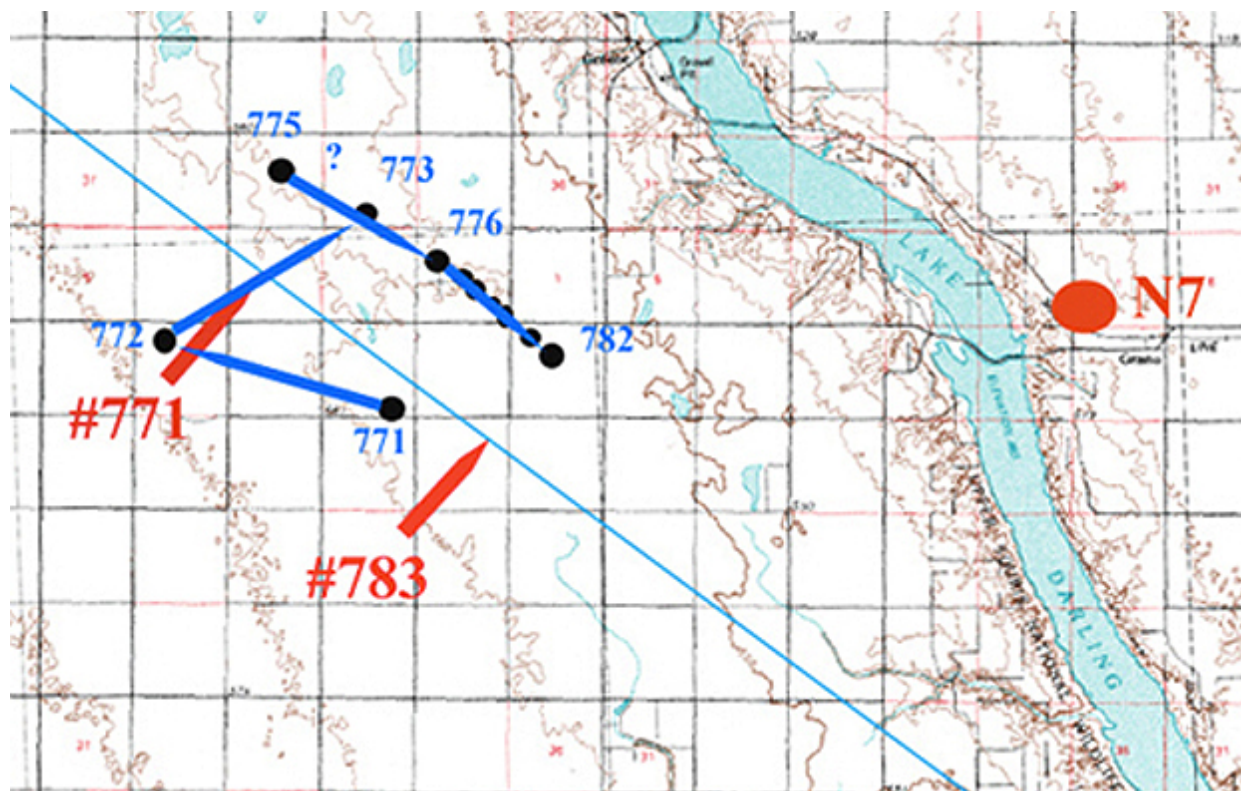

Figure 41. Real trajectory of the UFO (in blue) during the radar photos in the case of a co-altitude with B-52. The position of the UFO during photo 774 is unknown.

3.8. Influence of the Radar Beam-Sweep on the Size of the UFO Echo

The radar will paint the actual size of a target if the target is not moving relative to the radar antenna, though, as with all optical photography, a small rapidly moving target could appear enlarged on the radarscope if it is moving in the same direction as the radar beam sweep. Therefore, we can assume that the dimensions of the UFO radar echo could have increased artificially due to the high speed of the UFO, the rotation speed of the radar beam (120° / second), and the finite radar beam width.

We will ignore the actual angular beam width of the B-52 radar in azimuth, in order to be able to estimate the enlargement of the echo as a result of the finite beam width. We do know that the radar distance resolution was about 120 feet (36.6 m).

It is therefore probable that the radar angular (azimuth) resolution was such that at one nautical mile distance the resolution in distance and azimuth was of the same order of magnitude, corresponding to an angle of 1.13 degrees in azimuth, elapsed by the rotation of the antenna in only 9 milliseconds. Given the highest speed we have calculated (20466 km / h), the maximum lateral displacement of the UFO at a distance of 1 nm would have been only 51 meters during the 9 milliseconds of beam sweep. We can therefore infer that the dimensions of the echo were not dramatically altered (less than 20 %) by the relative speed of the UFO and the sweep-speed of the radar beam.

Since the radarscope photographs record only instantaneous positions, it is probable that the actual UFO movements correspond to a spiraling trajectory around a vertical axis beneath the B-52. As we will see, the orientation of the main axis of the UFO has nothing to do with the successive positions of the echo on the photographs, because the real trajectory of the UFO between the photos is unknown.

3.9. Orientation of the Main Axis of the UFO

Witness accounts suggest that the UFO likely had a distinctly ovoid shape, which is also discernible in the radar photographs. It is intriguing to compare the orientation of the long axis of the echo (green color) with the trajectory of the UFO (blue color), as well as to the positions of the B-52, which is moving along the blue line from the upper left to the lower right at a speed of about 460 km/ h (285 mph). In the following illustration, the UFO is assumed to be at the same altitude as the B-52. This being the case, we can now extend the UFO trajectory radially at this scale.

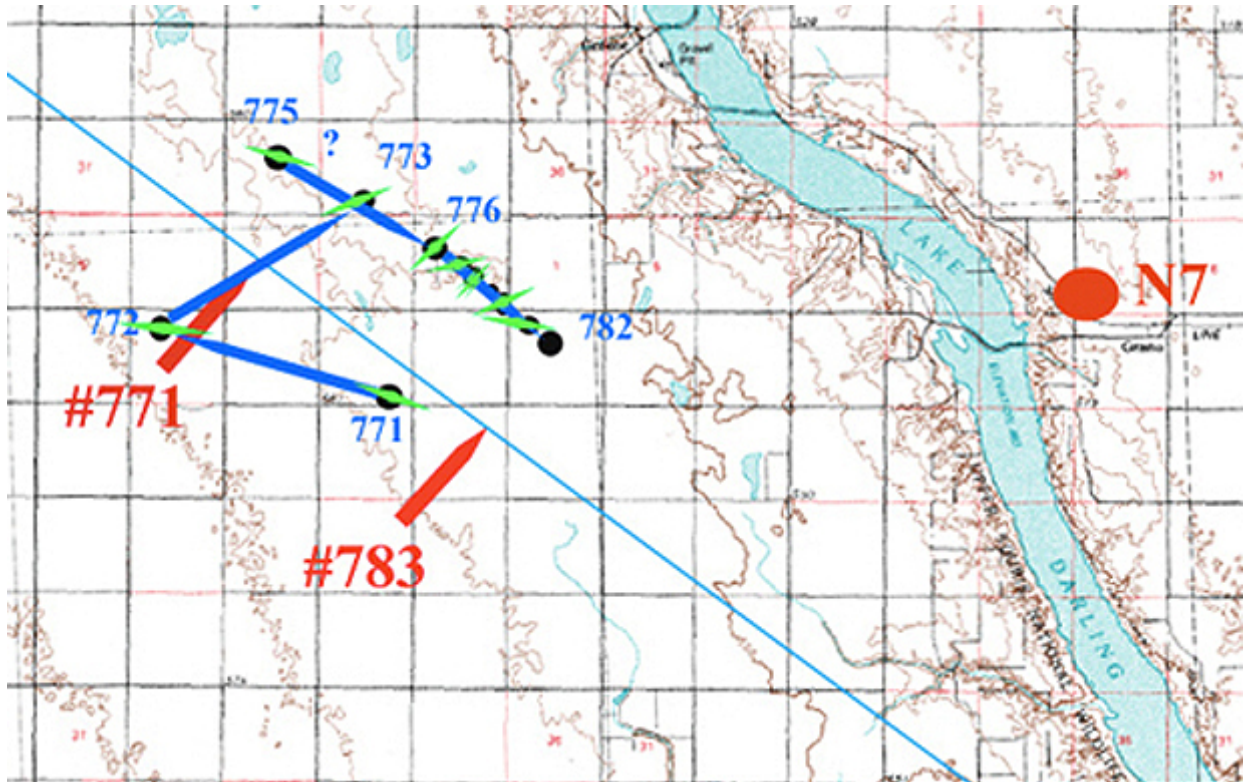

Figure 42. Trajectories of the B-52 and UFO. The orientation of the main axis of the ovoid echo is represented in green on the trajectory of the UFO represented in blue.

We observe that the successive orientations of the main axis of the UFO are virtually never parallel to the straight trajectory of the B-52. In numerous photos (especially photos 776 to 782), the axis of the UFO echo is nearly perpendicular to the trajectory of the B-52.

Part 4. 3-D Analysis of the Radarscope Photographs

4.1. B-52 Altitude and Radar Antenna Tilt-up

Let us now return to the calculations presented in equations (21) to (30), which determine fairly precisely the location of the B-52. We also have a good idea of its speed (254 knots), even though the calculations below were established for an average speed at 250 kts We know that:

$$\text{Dis783} = 35 - 18.8 \text{ nm} = 16.2 \text{ nm} \quad (32)$$

$$\text{Dis783} - \text{Dis771} = 2.57 \text{ nm. Therefore, Dis771} = 13.63 \text{ nm.} \quad (33)$$

Let us assume that this distance is determined from the beginning of the descent at 35 nm from the TACAN transmitter:

$$\text{Alt771} + 0.284 = 3.2625 - 0.1279048 \text{ Dis771.} \quad (22)$$

Therefore:

$$\text{Alt771} = 1.235 \text{ nm or 7500 feet} \quad (34)$$

and we determine that:

$$\text{Alt783} = 0.8272727 \text{ Alt771} \quad (12)$$

$$\text{Alt783} = 1.022 \text{ nm or 6205 feet.} \quad (35)$$

These are ground altitudes and not mean sea level altitudes, which would be resolved by adding 1723 feet. As a result of these calculations, we have positioned the B-52 in the three axes during the sequence of the radarscope photographs. Let us now return to the determination of the tilt angle of the antenna radar and review our data thus far:

- **Radius of the altitude hole in photo 771 = 2.20 nm**

- **Alt771 = ground altitude of the B-52 during photo 771 = 1.235 nm**
- **Radius of the altitude hole in photo 783 = 1.82 nm**
- **Alt783 = ground altitude of the B-52 during photo 783 = 1.022 nm.**

We have now verified that the real altitude of the B-52 is actually less than the radius of the altitude hole in the photographs. Next we will reprise the variables we used in prior equations:

- **Tilt = tilt angle of the radar antenna towards the sky (tilt-up). Tilt is also the half angle at the summit of the blind cone of the radar, centered on the nadir of the B-52.**
- **$K = \text{Cos}(\text{Tilt})$**
- **Alt771 = ground altitude of the B-52 during photo 771 (in nautical miles equivalent to 1 nm = 1852 m, or 6072 feet).**
- **Alt783 = ground altitude of the B-52 during photo 783 (in nautical miles).**

We have already clarified that:

$$\text{Alt771} = 2.20 K \quad (1)$$

$$\text{Alt783} = 1.82 K. \quad (2)$$

Therefore, with the values we generated in equations (34) and (35):

$$K = \text{Alt771} / 2.20 = 0.5613636 \quad (1 \text{ bis})$$

$$K = \text{Alt783} / 1.82 = 0.5615385 \quad (2 \text{ bis})$$

- **Tilt = Arc Cos (K) = 55.8°.**

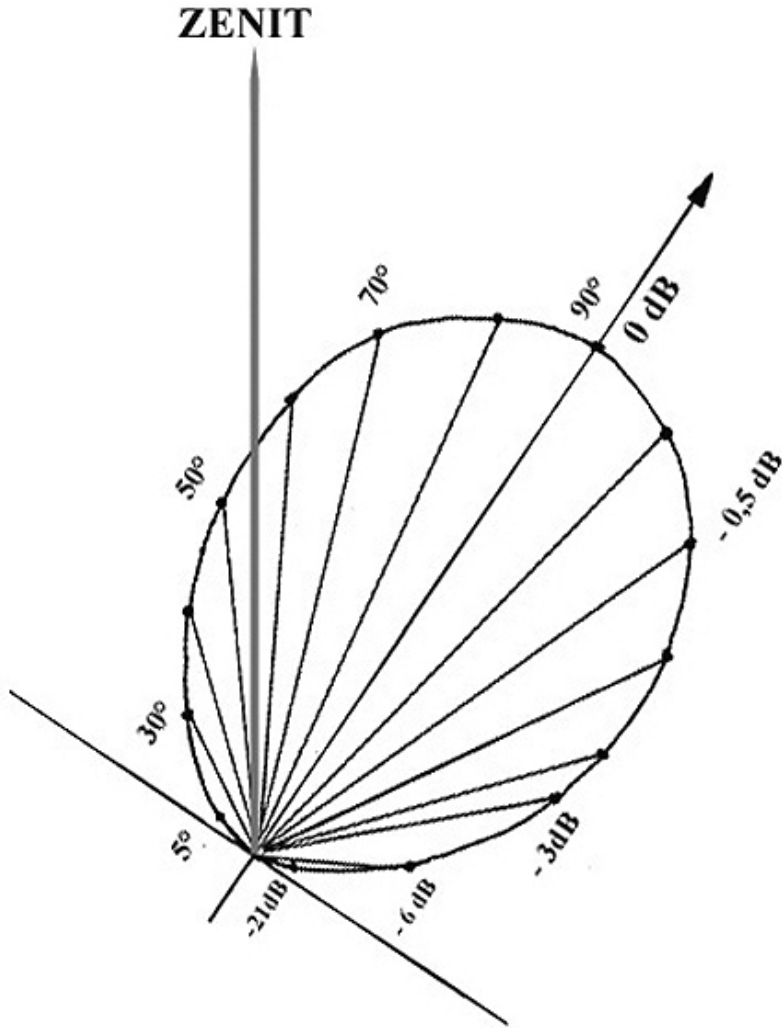

Figure 43. Illustration of the probable radar microwave beam at the calculated tilt (55.8°).

In effect, we know from the training manual that in Station Keep mode the radar could not capture information in the vertical direction below the aircraft, because the radar microwave beam (towards 9000 Mhz) was limited to about 60 degrees in the vertical plane. As a result of the previous calculations, 34.2 degrees downward, and 25.8 degrees above the horizontal. Of course, the angle between the nadir (vertical local downward) and the horizontal is equal to 90 degrees, and the radar would only begin receiving echoes in the downward direction of the ground at 45 degrees from the local vertical. It is therefore possible to carry out a trigonometric calculation to determine the altitude from the angular distance at which the radar begins to

display the ground at the contrasted edge of the altitude hole. When we examine this transition of the radar return signal at the level of pixels we find:

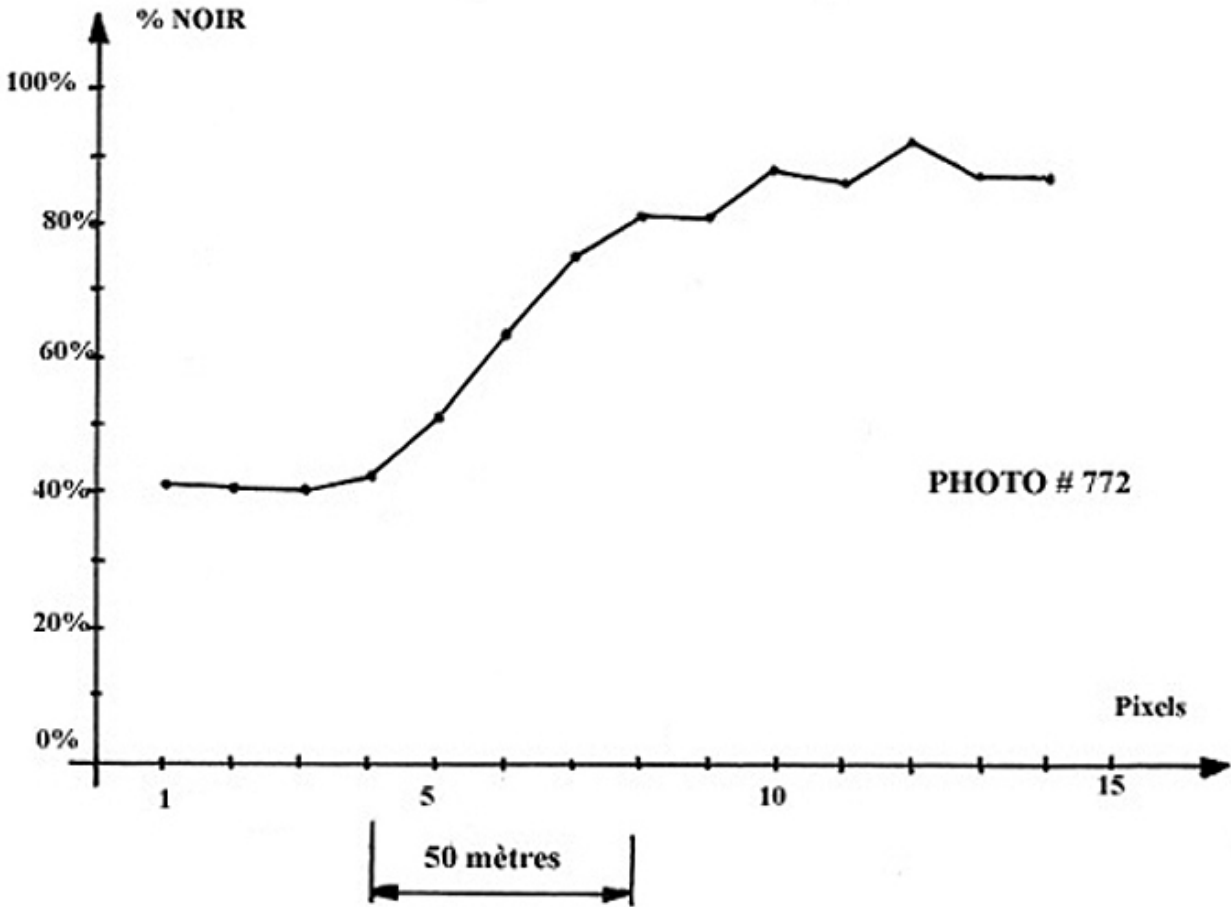

Figure 44. Contrast transition of the radar signal at the edge of the altitude hole for photo 772 (all photos are identical). The complete transition is made in 4 to 5 pixels.

The transition is made over a distance of 50 meters, which is comparable to the resolution in distance of the radar stated in the technical manual. As a result, there was an inclination of 55.8 degrees of the radar antenna upwards with an abrupt reduction of the radar sensitivity towards the nadir.

It is interesting to note in Figure 44 that variations from pixel to pixel in the ground echo are the normal quantification *noises* of the radar and have an average value in the order of 80 to

90 %. The standard deviation of the fluctuations must be equal to the square root of the average value, which is 8.9 to 9.5 %, corresponding positively to the order of magnitude of the real fluctuations from pixel to pixel. This detail proves that these are actual radarscope photos, since the only way to acquire such a quantification noise is to receive a returned radar signal that is emitted in quanta (microwave photons). We can now return to the hypothesis of the position of the UFO beneath the B-52 and determine its parameters.

4.2. Hypothetical Displacements and Speeds of the UFO

We have considered that the UFO was probably located at a lower altitude than the B-52, except in photo 775. In these circumstances, the geometry for calculating distances is further complicated and we must take into account radar azimuths, as well as the values of the calculated alpha angles that are augmented by the 55.8-degree upward inclination of the antenna radar. This changes the traveled distances and the previous *average* speeds as follows:

- **The position of the UFO changes between photos 771 and 772 from: 1.73 nm for 138° to 1.12 nm for 244°. Alpha + Tilt = 55.8 + 32 and 55.8 + 12.8° respectively. This indicates an angle nadir/UFO of 87.8° and 68.6°.**

To solve this equation we must use spherical trigonometry. Let us call **A** the angle at the top of the triangle constituted by the segment B52-UFO of departure and the segment B52-UFO of arrival of the UFO, such that:

$$\cos A = \cos (68.6^\circ) \cdot \cos (87.8^\circ) + \sin (68.6^\circ) \cdot \sin (87.8^\circ) \cdot \cos (244^\circ - 138^\circ) \quad (36)$$

Let us call **D** the distance traveled by the UFO:

$$D^2 = (1.73)^2 + (1.12)^2 - 2 \cdot 1.73 \cdot 1.12 \cdot \cos A \quad (37)$$

- This corresponds to a displacement $D = 2.277$ nm in 3.77 seconds, which is an *average* speed of 2174 knots, or 4028 km / h (2502 mph).

It follows that:

- The position of the UFO changes between photos 772 and 773 from: 1.12 nm for 244° to 1.05 nm for 039° . Alpha + Tilt = $55.8 + 12.8$ and $55.8 + 13.3^\circ$ respectively. This indicates an angle nadir/ UFO of 68.6° and 69.1° . This corresponds to a displacement $D = 1.98$ nm in 1.29 seconds, which is an average speed of 5515 knots, or 10213 km / h (6346 mph).
- The position of the UFO changes between photos 773 and 775 from: 1.05 nm for 039° to 1.69 nm for 348° . Alpha + Tilt = $55.8 + 13.3$ and $55.8 + 45^\circ$ respectively. This indicates an angle nadir/ UFO of 69.1° and 100.8° . This corresponds to a displacement $D = 1.47$ nm in 5.58 seconds, which is an average speed of 945 knots, or 1750 km / h (1087 mph).

A possible interpretation of the 100.8 degrees for the angle nadir / UFO is that the UFO was slightly above the B-52 altitude during photo 775, if UFO and ground radar reflectivity were the same.

- The position of the UFO changes between photos 775 and 776 from: 1.69 nm for 348° to 1.08 nm for 040° . Alpha + Tilt = $55.8 + 45^\circ$ and $55.8 + 12.8^\circ$ respectively. This indicates an angle nadir/ UFO of 100.8° and 68.6° . This corresponds to a displacement $D = 1.49$ nm in 3.43 seconds, which is an average speed of 1563 knots, or 2894 km / h (1860 mph).

Note that the speeds are relative to the B-52's forward speed at about 250 knots, or 460 km / h (285 mph). In fact, these calculations show only minor UFO position changes across photos.

4.3. Minimal Accelerations of the UFO

Since the UFO trajectory is angular, we might want to hypothesize a uniform acceleration of the UFO across photos, even though we do not know exactly how the UFO changed directions between photos. In any case, we can calculate minimal accelerations of the UFO. If **A** is the acceleration, and **D** the distance traveled during time **T**, we have the following relationship:

$$\mathbf{A} = 2 \cdot \mathbf{D} / \mathbf{T}^2 \quad (38)$$

- **Between photos 771 and 772 the UFO position changes by 2.277 nm (4217 m) in 3.77 seconds, corresponding to an acceleration of 493 m/s². This is more than 60 g.**
- **Between photos 772 and 773 the UFO position changes by 1.98 nm (3667m) in 1.29 seconds, corresponding to an acceleration of 4407 m/s². This is more than 449 g.**
- **Between photos 773 and 775 the UFO position changes by 1.47 nm (2722 m) in 5.58 seconds, corresponding to an acceleration of 175 m/s². This is about 18 g.**
- **Between photos 775 and 776 the UFO position changes by 1.49 nm (2759 m) in 3.43 seconds, corresponding to an acceleration of 469 m/s². This is about 48 g.**

All of these accelerations are compatible with the performances necessary for an interstellar voyage.¹⁶

Furthermore, during the course of the photo sequences:

- **771, 772, and 773, there is an abrupt change of direction and displacement of the UFO executed in less than 1.3 seconds, at a 50-degree angle towards the right.**
- **772, 773, and 775, there is an abrupt change of direction and displacement of the UFO executed in less than 6 seconds, at a 50-degree angle towards the left.**
- **773, 775, and 776, there is an abrupt change of direction and displacement of the UFO executed in less than 4 seconds, at an angle of 180 degrees.**

Since the radarscope only displays a static transitory position of the UFO, at the brief and precise location when the radar beam swept it, we have no means to determine the radius of these turns, nor whether they were direct displacements followed by an abrupt stop and acceleration in a new direction (or whether there were multiple UFOs). Nevertheless, given that the radar echoes are instantaneous, it is reasonable to consider a scenario in which the echo was actually in constant motion throughout the series of photos.

4.4. Minimal Speeds Attained by the UFO

The hypothesis of a UFO located below the altitude of the B-52 for most of the photo sequence (except during the course of photo 775) is further reinforced by the variations of the intensity of the radar echo between photos. This hypothesis is also confirmed by the fact that photo 774 does

¹⁶ This is further explicated on the author's web site at: <http://www.universons.com/>.

not show an echo, which suggests a passage of the UFO beneath the B-52 in the blind cone of the radar. The summit angle of this cone is equal to 90 degrees. Based on the minimum UFO acceleration speed **A** at time **T** we can calculate speed **V** as follows:

$$V = A T \quad (39)$$

- **Between photos 771 and 772 acceleration is 493 m/s² during 3.77 seconds; the speed could be 1858 m/s (Mach 5.4). That is 6688 km / h (4155 mph).**
- **Between photos 772 and 773 acceleration is 4407 m/s² during 1.29 seconds; the speed could be 5685 m/s (Mach 16.7). That is 20466 km / h (12716 mph).**
- **Between photos 773 and 775 acceleration is 175 m/s² during 5.58 seconds; the speed could be 977 m/s (Mach 2.9). That is 3515 km / h (2184 mph).**
- **Between photos 775 and 776 acceleration is 469 m/s² during 3.43 seconds; the speed could be 1609 m/s (Mach 4.7). That is 5791 km / h (3598 mph).**

These calculations show that the UFO was **supersonic** during its flight, which should have produced a loud sonic boom time and again, though none was reported, as is generally the case with other reported supersonic UFOs. Nevertheless, these speeds are clearly beyond all aeronautical developments in 1968.

4.5. 3-D Positions of the UFO in Relation to the B-52

In Figure 45, I have illustrated the angular distances of the UFO in relation to the B-52 for photos 771, 772, 773 and 775, based on the indicated azimuth direction, and calculated altitude angle in the respective radarscope photos.

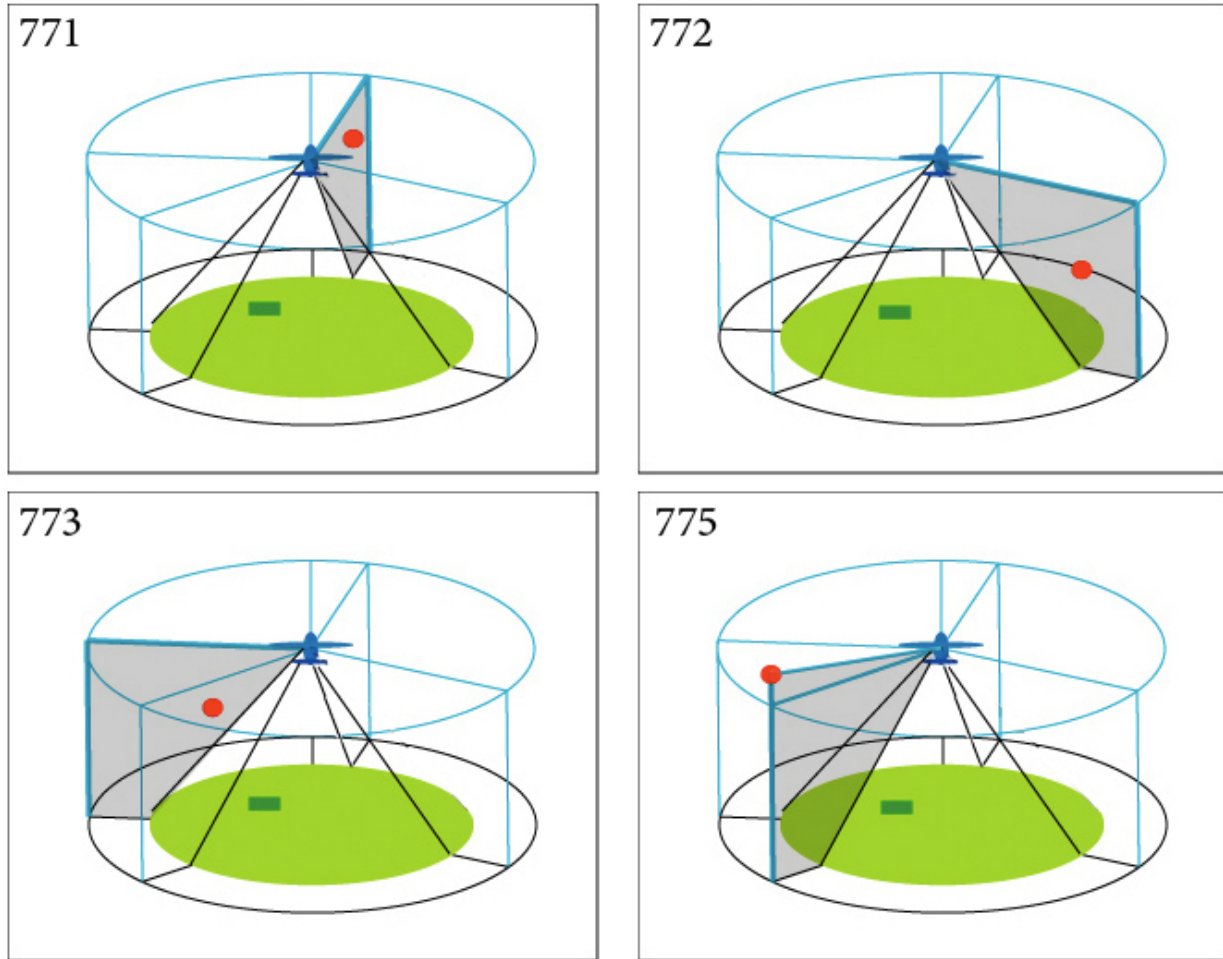

Figure 45. Sequence of four illustrations showing UFO positions in relation to the B-52. For photos 776-782 the position of the UFO is consistent with 773, at about 1 nm off the left wing.

The external circle has a radius of 4 kilometers, and the successive positions of the UFO (red circle) in relation to the B-52 are roughly to this scale in distance. However, the ground altitude, and sizes of the UFO and B-52 are not to scale. The solid green circle represents the blind radar zone, extending from the B-52 to the ground beneath the B-52, and the small green rectangle represents an imaginary detail of the landscape under the aircraft. The successive azimuth directions (vertical planes) are shaded and highlighted in bold blue. Although this illustration is imprecise, it will help to visualize the trajectory of the UFO in 3-dimensional space.

The illustration in the lower right represents radarscope photo 775, in which the UFO is located *above* the altitude of the B-52. This position takes into account two facts. On the one hand, the UFO echo is as intense as the ground echo on this photo, so it is conceivable that the UFO was closer to the axis of the radiance lobe of the radar antenna and therefore above the horizontal plane. On the other hand, it is necessary to take into account the successive intensities of the radar echo of the UFO, as well as the radiance diagram of the radar antenna in the vertical plane. Let us review the results of the photometric measurements on the radarscope photos:

| Cliché | Echo % | Sol % | Echo/Sol % | Distance (nm) |
|---------------|---------------|--------------|-------------------|----------------------|
| 771 | 67 | 91 | 74 | 1,73 |
| 772 | 58 | 91 | 64 | 1,12 |
| 773 | 81 | 91 | 89 | 1,05 |
| 775 | 94 | 89 | 106 | 1,69 |
| 776 | 56 | 90 | 62 | 1,08 |
| 777 | 47 | 84 | 56 | 1,05 |
| 778 | 61 | 78 | 78 | 1,05 |
| 779 | 51 | 80 | 64 | 1,00 |
| 780 | 66 | 80 | 83 | 1,05 |
| 781 | 52 | 90 | 58 | 0,95 |
| 782 | 52 | 90 | 58 | 0,91 |

Table 6. Results of the photometric study of the radar photos. Sol = Ground.

In Table 6, the fourth column (**Echo/Sol%**) presents the ratio of the intensity of the UFO echo, divided by the intensity of the ground echo at the edge of the altitude hole. We see that during photo 775 the echo has about the same intensity as the ground, and the distance separating

the UFO from the B-52 is 1.69 nm (3130 meters). Earlier, we calculated the ground altitude of the aircraft for photos 771 and 783, and found:

- **Alt771 = 7500 feet (1.235 nm, or 2288 m)**
- **Alt783 = 6205 feet (1.022 nm, or 1893 m).**

During photo 775 the distance between the UFO and the B-52 is greater than the distance between the B-52 and the ground. Therefore, if the radar albedo of the UFO and the ground are assumed to be of the same magnitude, and the sensitivity is equal in both directions, we should receive radar signals of different intensities. However, we do not accurately know the sensitivity of the radar versus the direction of the target in the vertical plane, although the technical training manual indicates that it varies in cosecant square. Since we have calculated the tilt angle of the antenna upwards at 55.8 degrees, the sensitivity of the B-52 radar in the vertical plane probably varies as the theoretical function represented in Figure 46:

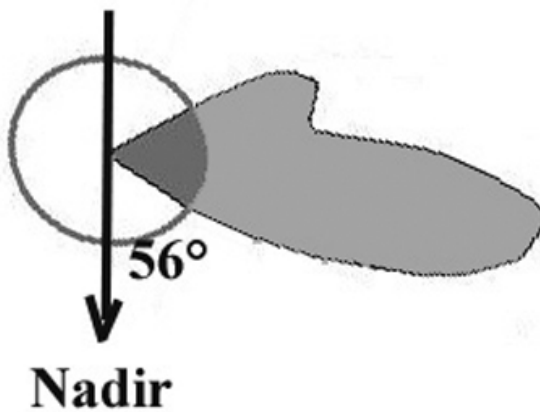

Figure 46. Diagram of vertical sensitivity of the B-52 radar antenna tilted up by 55.8°.

The radar antenna rotates around a vertical axis with a maximum sensitivity at roughly 10 degrees under the horizon. It is therefore blind within an angle of 111.6 degrees below the B-52

as confirmed by the photographs. We also note that the ground echo at the periphery of the blind zone corresponds to a point of low radar sensitivity, which would attenuate to 20 dB in comparison to the maximum sensitivity. Since the intensity of the radar echo of the UFO is of the same magnitude as the intensity of the ground echo at 56 degrees from the vertical, and at a ground altitude of the same distance of the UFO, this would mean that the signal of the UFO echo was attenuated even more and by different causes than the signal of the ground echo. Because the ground echo is 1.4 times the distance separating the UFO from the B-52, in principle, the ground echo was more distance-attenuated by a factor of $1.4^4 = 3.8$ or 6 dB. Therefore, the UFO echo should be two times brighter than the ground echo for the same albedo, which is not the case.

Two possible causes exist for this difference in attenuation: a different orientation in the radar antenna diagram, or some absorption inside the ion cloud surrounding the UFO. In order to reconcile photometric results with the established sensitivities of the radar in the vertical plane, we have assumed that *during photo 775 the UFO was essentially at the same altitude as the airplane, and possibly a little above it*. This assumption has to remain conjecture because we cannot infer the exact sensitivity diagram of the B-52 radar antenna, and the absorption of the ion cloud. However, by comparing the successive photos and assuming a constant ionic absorption, the hypothesis that the UFO was higher in altitude than the B-52 during photo 775 seems the most plausible solution given the physical evidence. Note that in photo 774 the echo of the UFO has disappeared, which would be possible if the UFO were situated in the blind cone of the radar beneath the B-52, resulting in a continuous UFO trajectory between photos 773 and 775.

The 3D reconstruction of the trajectory implies that the UFO spiraled below and around behind the B-52 at an extremely high rate of speed (in about 15 seconds), while also maintaining

a relative distance of 1-2 nautical miles *and* the corresponding forward trajectory of the B-52 at 250 knots.

4.6. Energetic Aspects of the UFO

As we have determined previously, the radar photographs show a very rapid displacement of the UFO as follows:

- **Between photos 771 and 772, the UFO acceleration is 493 m/s^2 during 3.77 seconds, resulting in a speed of 1858 m/s (4155 mph).**
- **Between photos 772 and 773, the UFO acceleration is 4407 m/s^2 during 1.29 seconds, resulting in a speed of 5685 m/s (12176 mph).**
- **Between photos 773 and 775, the UFO acceleration is 175 m/s^2 during 5.58 seconds, resulting in a speed of 977 m/s (2184 mph).**
- **Between photos 775 and 776, the UFO acceleration is 469 m/s^2 during 3.43 seconds, resulting in a speed of 1609 m/s (3598 mph).**

Furthermore, the ground witnesses described large angular speeds and some form of angular trajectories, which imply large accelerations. We will therefore calculate a magnitude of the *minimal* kinetic energy of the UFO during its rapid maneuvers. This parameter is of particular interest since it must conform to the natural law of energy conservation, that is, the kinetic energy of a moving mass must be derived from *somewhere*. The only available information we have comes from terrestrial technology, which suggests that the energy must come from the aircraft's engine and its onboard fuel supply. The calculation of the kinetic energy E_c relies on a well known classical mechanics law, where the mass M of the craft, and its speed V are related as follows:

- $E_c = \frac{1}{2} M V^2$.

Note that we are conservative in our estimation by ignoring the total mass **M** of the observed UFO. We shall postulate several hypotheses given our empirical data. Firstly, that the UFO (or UFOs) might have been an inhabited vehicle because the trajectory was seemingly strategic and the vehicle was sizeable and traveled at an enormous speed.

In 1977, I assembled the dimensions and total masses of various kinds of terrestrial vehicles in order to get comparative references to determine their average statistical mass per cubic meter. In this instance, if we know the size of a UFO, we can calculate its volume and these statistics could help us determine its approximate total mass by anthropomorphic hypotheses. The 1977 statistics revealed an unexpected result. The dispersion of the density of all types of vehicles is relatively low, and this density is almost statistically always between two extremes that are separated by a factor of only two.

At one end are *heavy technology vehicles* such as trains, trucks, commercial aircraft and competition sail boats, which are around **300 kg / m³**. At the other end are *light technology vehicles* such as private aircraft, cars, automatic satellites and space stations, which are around **150 kg / m³**. Based on these two extremes, we shall assume that the total mass of the Minot UFO was between 150 and 300 kg per cubic meter of the total volume. The dimensions of the Minot UFO have been deduced from the various witness descriptions and are fairly coherent. Of course, the following considerations are not accurate values but orders of magnitude. For our evaluation we will use the UFO dimensions reported by the B-52 copilot Capt. Runyon, since he observed the UFO in close proximity.

From Figure 56 we determine that the UFO had a complex volume of about 60 x 30 x 15 meters, which is a total volume in the order of **27000 cubic meters**. Two of the ground witnesses

reported that the UFO was “slender” and had a smaller height than the horizontal width compared to the UFO reported by the pilots. If the UFO shape were as flat, as is suggested by the drawings, the total volume would be about half to a third of the previous figure, which would simply mean that we have to divide our final results by a factor of 2 or 3. In any case, these adjustments would not change the conclusion. According to the average statistical densities of terrestrial vehicles, the Minot UFO might have had a total mass between **4 and 8 million kg** (4000 to 8000 metric tons). Consequently, by using the previous equation to calculate the kinetic energy E_c , we get:

- **Between photos 771 and 772, the UFO acceleration is 493 m/s^2 during 3.77 seconds, resulting in a speed of 1858 m/s; and a kinetic energy between 0.69 and $1.38 \cdot 10^{13}$ Joules.**
- **Between photos 772 and 773, the UFO acceleration is 4407 m/s^2 during 1.29 seconds, resulting in a speed of 5685 m/s; and a kinetic energy between 6.5 and $12.9 \cdot 10^{13}$ Joules.**
- **Between photos 773 and 775, the UFO acceleration is 175 m/s^2 during 5.58 seconds, resulting in a speed of 977 m/s; and a kinetic energy between 0.19 and $0.38 \cdot 10^{13}$ Joules.**
- **Between photos 775 and 776, the UFO acceleration is 469 m/s^2 during 3.43 seconds, resulting in a speed of 1609 m/s; and a kinetic energy between 0.52 and $1.03 \cdot 10^{13}$ Joules.**

Thanks to the radarscope clock, we know the precise time in seconds between each photo during which the kinetic energy of the UFO was accumulated. Based on these data we can

calculate the power output of the UFO *engine*. The power is simply the kinetic energy per second of time.

- **Between photos 771 and 772, the UFO acceleration is 493 m/s^2 during 3.77 seconds, resulting in a speed of 1858 m/s; and a kinetic energy between 0.69 and $1.38 \cdot 10^{13}$ Joules. This corresponds to 1800 to 3600 gigawatts of kinetic energy per second of time.**
- **Between photos 772 and 773, the UFO acceleration is 4407 m/s^2 during 1.29 seconds, resulting in a speed of 5685 m/s; and a kinetic energy between 6.5 and $12.9 \cdot 10^{13}$ Joules. This corresponds to 50400 to 100800 gigawatts of kinetic energy per second of time.**
- **Between photos 773 and 775, the UFO acceleration is 175 m/s^2 during 5.58 seconds, resulting in a speed of 977 m/s; and a kinetic energy between 0.19 and $0.38 \cdot 10^{13}$ Joules. This corresponds to 340 to 680 gigawatts of kinetic energy per second of time.**
- **Between photos 775 and 776, the UFO acceleration is 469 m/s^2 during 3.43 seconds, resulting in a speed of 1609 m/s; and a kinetic energy between 0.52 and $1.03 \cdot 10^{13}$ Joules. This corresponds to 1500 to 3000 gigawatts of kinetic energy per second of time.**

These powers are enormous. By comparison, a single modern nuclear electric power plant delivers a peak power of 1.3 gigawatts. Even if we simply consider the lowest values, the Minot UFO was capable of producing a mechanical power comparable to *260 to 39000 actual*

nuclear power plants. These enormous mean values make it unnecessary to calculate the maximum values.

Of course, these evaluations are approximations, but they are nevertheless justified given the reported and observed performances of the UFO confirmed by the B-52 radar. This magnitude of power demonstrated by a *machine* that has little in common with our current understanding of energy technology and production raises several fundamental questions:

- **What is the nature of the UFO's *energy*? We know of nothing that could approach the preceding values.**
- **What is the source of the UFO's *energy*? We do not know of any means to supply such levels of energy and deliver it so quickly.**¹⁷

The order of magnitude of the acceleration allows us to extrapolate that this UFO would be able to attain a relativistic speed in a brief period of time (less than a day), if it could sustain the accelerations that were calculated. For example, acceleration in the order of the 450 *g* observed between photos 772 and 773 would attain 80% of the speed of light in approximately 15 hours. Given this speed, the relativistic time compression would become negligible, and the onboard clock, as well as the metabolism of the occupants would slow down. Under such conditions, interstellar travel becomes compatible with the life expectancy of the occupants of the vehicle.

In order to declare with relative certainty that interstellar travel is feasible, we have to concede with difficulties other than speed. The second substantial difficulty is the *massive quantity of kinetic energy* necessary to attain a relativistic speed. This enormous energy must be

¹⁷ The web site <http://www.universons.com> attempts to answer these questions on the basis of our actual knowledge of physics without calling for extraordinary hypotheses. We should also ask ourselves about **the origin** of these UFOs!

expended to accelerate and decelerate, in order to arrive with a null speed. The Minot UFO suggests that in nature there exists a form of energy to accomplish this.

In any case, it seems to me that the discovery of this kind of energy and the means to extract it should be the highest priority for humankind, even if the Minot UFO observations bring only concordant clues and not absolute proofs.

4.7. Discussion 1: The B-52 Altitude and the Tilt-up Angle of the Radar Antenna

During the process of reconstructing the flight path of the B-52 and dynamic behavior of the UFO, we measured the following quantities from the radarscope photos:

- **The B-52 oblique distance and azimuth to the Lake Darling feature in photo 783.**
- **The B-52 horizontal speed during photos 782 and 783.**
- **The UFO radar echo distance and azimuth in all photos where a UFO was painted.**
- **The UFO radar echo average speed in 2-D space during all photos where a UFO was painted.**
- **The 2-D radar size of the UFO target in the successive photos.**
- **Details have also revealed that the photos were made from a real aircraft having the characteristics of a B-52.**

These measurements are quite consistent with the observer accounts, primary documentation and quantitative evidence. The unusual behavior of the UFO was clear in this reconstruction, particularly from the 2-D speeds and accelerations obtained during this first,

more classical approach. These parameters are quite reliable because they were obtained from measurements made by a then state-of-the-art instrument. Notably, this type of radar is not able to provide 3-D (altitude) positions. However, we have several circumstances that allow us to theoretically determine the 3-D parameters from calculations based on known laws of physics and aeronautical constraints of the B-52 in flight. From these theoretical calculations we get the following parameters:

- **The Tilt-up angle of the radar antenna.**
- **The B-52 altitude during the photos.**
- **The 3-D positions of the UFO.**
- **The 3-D minimum speeds of the UFO.**
- **The 3-D minimum accelerations of the UFO.**
- **The minimum kinetic energy of the UFO.**
- **The minimum power of the UFO propulsion.**
- **The approximate size of the cloud of ionized air surrounding the UFO, and the approximate theoretical minimum value of the particle charge density of this cloud.**
- **A theoretically coherent explanation for the VHF radio transmission failure.**

For most of these theoretical calculations the necessary assumptions are known, but certain calculations contain *hidden hypotheses* that should be discussed in order to provide an understanding of the limits of the methods used. In order to grasp these *hidden hypotheses*, it is necessary to recall that the photos of the B-52 radarscope were taken during the descent

trajectory from the WT fix. The potential trajectories were represented in Figure 47 (below) at an altitude scale five times that of the distance scale.

Here we face the first difficulty: In order to calculate the B-52 altitude during photo 783 (a position corroborated by the radar image of Lake Darling), we need a map to ascertain the B-52 distance from the Deering TACAN transmitter adjacent to the runway. Our original calculations were made with a map of the region that was included in the Blue Book documents, which was not at the same scale as the map used by Werlich in 1968.¹⁸

In his research of the Minot events, Tulien realized several anomalies concerning the position of the WT fix on the original map, and located a more accurate USGS map that covers the entire B-52 descent trajectory. Although the alignment of Col. Werlich's overlay did not match the USGS map, he had drawn several auxiliary details on his overlay, including contours of several small cities and roads, six latitude and longitude coordinates, and the virtual position of the initial approach fix, referred to as the "WT fix." After diagnosing the problems, we were able to adjust the overlay so that all of the details were in alignment on the USGS map, including the WT fix position, which was finally known with accuracy of about 35 meters (or about the same as the B-52 radar resolution). We discovered a different distance from the B-52 position during photo 783 to the Deering TACAN, which required a re-calculation of all the values we had originally obtained.

Here we found a second difficulty. Two of the first parameters calculated from the B-52 position during photo 783 were the *B-52 altitude*, and the *radar antenna tilt-up angle*, which correspond to the diameter of the altitude hole on each photo.

¹⁸ Col. Werlich based his overlay on a classified "200 series map chart which is used by the bomb people in the targeting section." See: http://www.minotb52ufo.com/mapsnew/werlich_overlay_scan.php. The scale of this map and his overlay is 1:200,000. The "base" map apparently used by Quintanilla (Blue Book staff) and included in the Blue Book records is an unclassified "Missile Complex Disaster Control Grid Map," with a scale denominator of 1:250,000. See: http://www.minotb52ufo.com/mapsnew/1965_grid.php.

The original map resolved a tilt-up angle of 45 degrees, which was consistent with the indications of the technical training manual for the radar. However, we found a larger angle of 55.8 degrees on the USGS map, which does not seem compatible with radar system specifications in the technical training manual. As can be seen in Figure 47, the B-52 altitude is calculated from the vertical trajectory of the B-52 beginning at the WT fix (FL200) and ending at the runway. In order to present the illustration, we used a different yet more accurate scale for the distance and the altitude. The altitude scale is five times the distance--in which case the altitudes are exaggerated by a factor of five. Additionally, we specify the positions of the B-52 nadir during photos 771 and 783, and four possible trajectories from the WT fix to the runway.

We have a verification of the *hidden hypothesis* that the B-52 trajectory from the WT fix to the runway was a straight line because the radar position of the B-52 during photo 783 is perfectly aligned with the runway on the new map. There is an upper black trajectory called “Minimum slope” that is directly joining the WT fix with the west end of the runway. Next, there is a (red) trajectory called “Probable slope” that joins the WT fix with the **Middle Marker (MM, or Final Approach Fix)** where, according to Minot AFB approach procedures, the altitude of the B-52 would be 3200 feet MSL.

The existence of the MM beacon and the corresponding approach procedure is another *hidden hypothesis* because this information was obtained from current 2003 Instrument Approach Procedures (approach plates) for Minot AFB.¹⁹ However, the Instrument Landing System (ILS), which incorporates the MM radio beacon existed at most airports at the time, so it seems probable that the same 2003 ILS approach procedures were in effect in 1968.

¹⁹ Terminal Procedures for Minot AFB, effective 15 May 2003 available from: http://www.minotb52ufo.com/mapsnew/map_images/ApproachPlates.pdf.

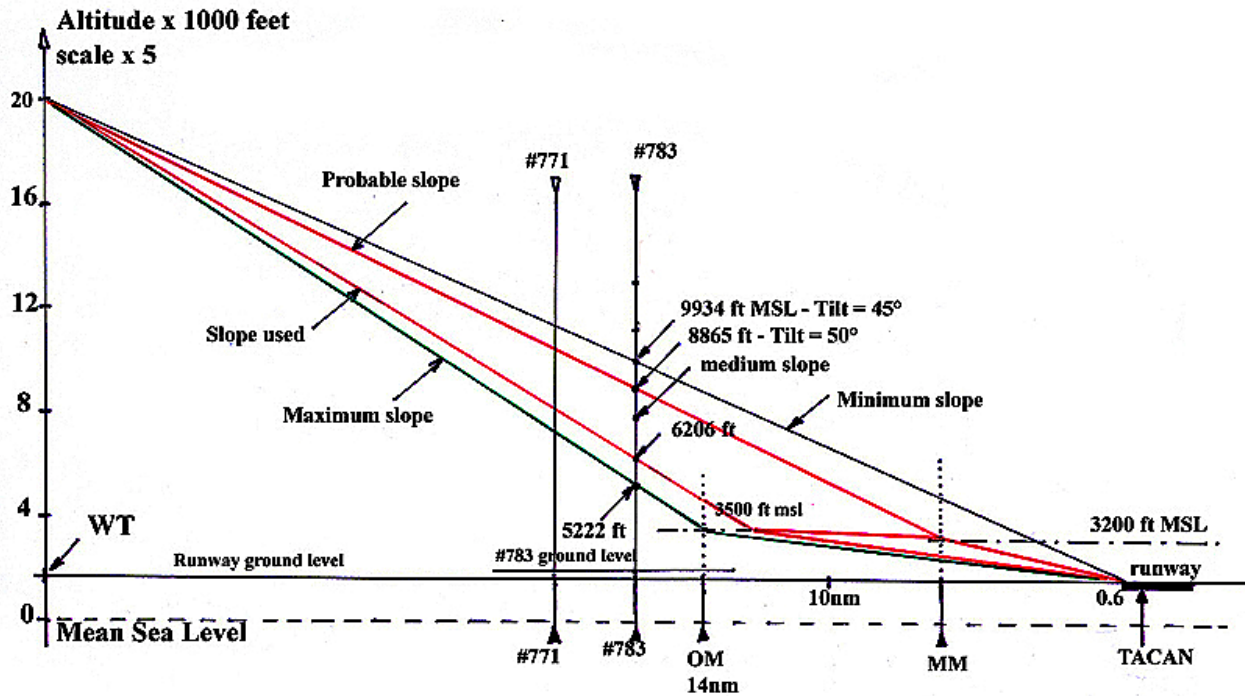

Figure 47. Four possible vertical trajectories of the B-52 during the descent from the WT fix at 20,000 feet altitude to the runway at Minot AFB (1723 feet above MSL). The positions of photos 771 and 783 are indicated, including the corresponding altitudes for photo 783.

Next, there is a lower green “Maximum slope” that joins the WT fix with the *Outer Marker (OM)* situated 14 nautical miles from the TACAN, where the aircraft would be at altitude 3500 feet MSL. From OM the most probable trajectory would have been to MM at 3200 feet before descent to the runway. There are new *hidden hypotheses* associated with this “Maximum slope” trajectory.

Between the “Probable slope” and the “Maximum slope” hypothetical trajectories, there is another red trajectory (“Slope used,” or “Report slope”) descending to 3200 feet MSL, and leveling out to the MM before descending to the runway. This intermediate lower trajectory is a result of the simple recalculation of the parameters after changing the map scale for the position of the B-52 during photo 783.

Figure 47 also shows the different possibilities for the B-52 altitude that correspond to the different *hidden hypotheses* concerning the four B-52 descent trajectories. We get the following altitude results:

- **B-52 altitude during photo 783 = 9934 feet MSL for the “Minimum slope” hypothesis.**
- **B-52 altitude during photo 783 = 8865 feet MSL for the “Probable slope” hypothesis.**
- **B-52 altitude during photo 783 = 6206 feet MSL for the recalculated “Report slope” hypothesis.**
- **B-52 altitude during photo 783 = 5222 feet MSL for the “Maximum slope” hypothesis.**

At each altitude the trigonometric equation generates a different value for the *tilt-up angle of the radar antenna*.

- **A tilt-up angle of 45° for the “Minimum slope” hypothesis**
- **A tilt-up angle of 50° for the “Probable slope” hypothesis, etc.**

Using this calculation, the 45-degree tilt-up angle seems to correspond to an impossible altitude for the B-52 at this moment. What is clear from the previous results is that *the B-52 altitude varies by a factor of 1.9 when we take into account the hidden hypotheses*. From the aeronautical (i.e., the pilot’s) point of view, it seems that the correct hypothesis is the descent that ends at the MM, although from the existing data we have no way to corroborate this hypothesis. This means that there is an uncertainty regarding the true B-52 altitude during photo 783. Further, because the tilt-up angle of the B-52 radar antenna is tied to the altitude hole radius

on photo 783, we cannot determine the tilt-up angle that is used in all 3-D calculations of the UFO positions through its sine and cosine values:

- **B-52 ground altitude = Photo alt hole radius. Cos (tilt up angle).**

This means that the *hidden hypothesis* concerning the descent trajectory has a direct influence on the 3-D results. However, this influence is not substantial, because the trigonometric results do not change considerably when the angle of the radar antenna is modified by 10 to 15%. Nevertheless, we need to consider the question of the radar antenna tilt-up angle.

Let us suppose that the B-52 radar antenna reflector is almost *flat* in the vertical direction and has a parabolic shape only in the horizontal direction. This is the case with many mapping radars antennas, and such a reflector shape is shown in the sensitivity diagram of Figure 48.

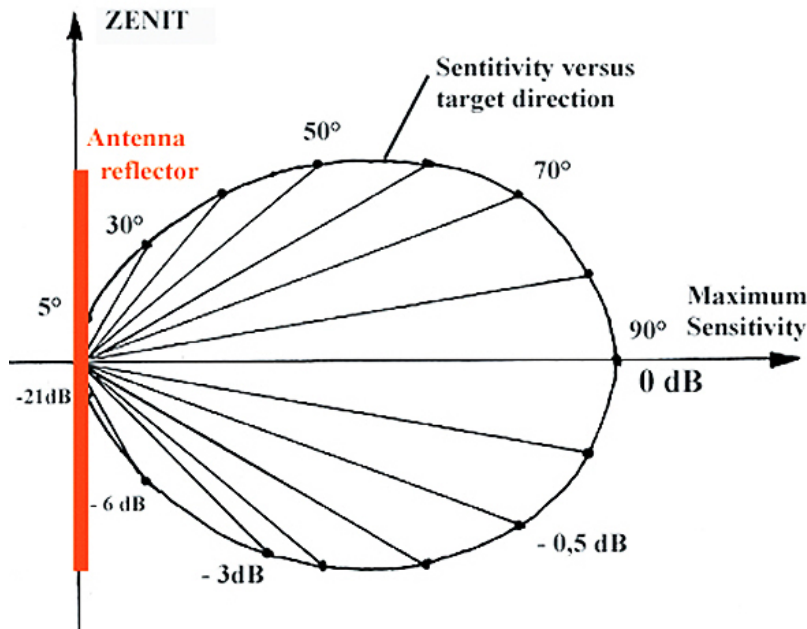

Figure 48. Hypothetical radar antenna diagram in the vertical plane.

In such a diagram, the output microwaves flux Φ in a direction making an angle α with the nadir of the antenna, is simply given by:

$$\Phi = \Phi_{\max} \sin (\alpha) \quad (40)$$

where Φ_{\max} is the maximum flux emitted in the direction $\alpha = 90^\circ$. When such an antenna is tilted up 45 degrees we get the following hypothetical radar antenna diagram:

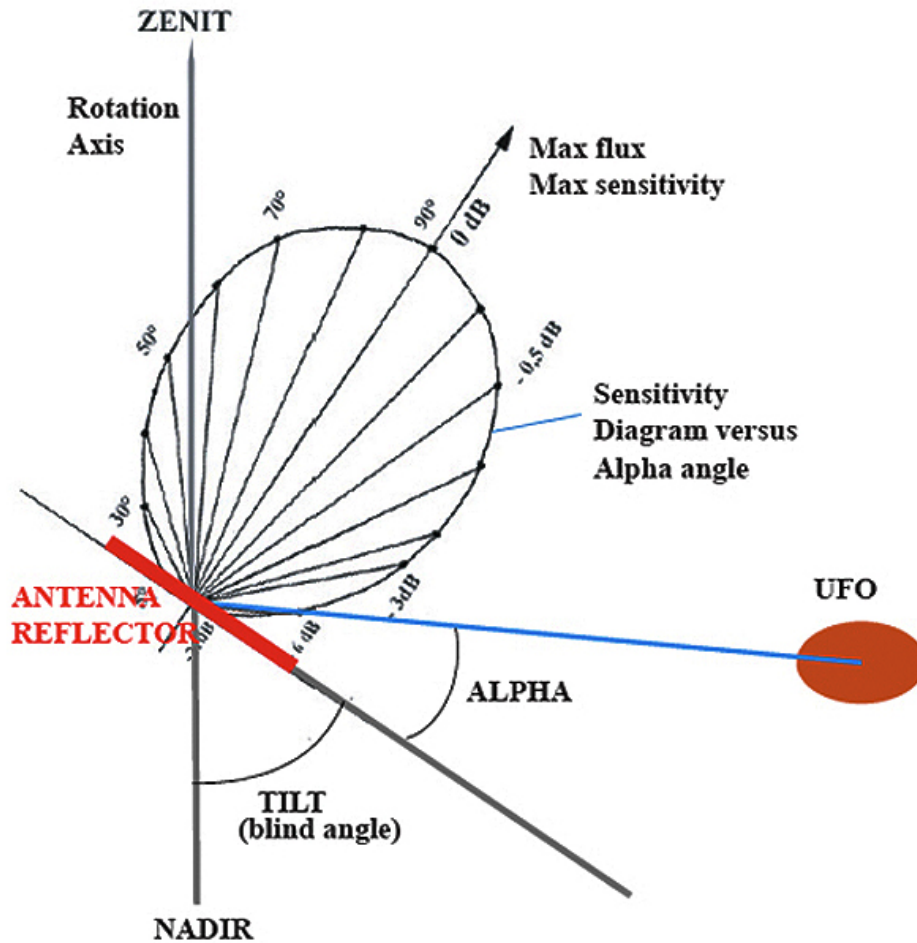

Figure 49. Hypothetical radar antenna diagram when the antenna is tilted up 45 degrees. The hypothetical tilted up antenna has a “blind” cone in the direction of the nadir, and the summit angle of the blind cone is two times the tilt-up angle of the antenna.

Even though the radar antenna diagrams are hypothetical, we can nevertheless attempt to verify these diagrams with the existing data.

In order to understand our method of verification, let us first examine the scenario beneath the B-52 during photo 783, perpendicular to the B-52 trajectory in the direction towards the southwest (lower left). In Figure 50, the isocontours indicating a difference of 10 meters of

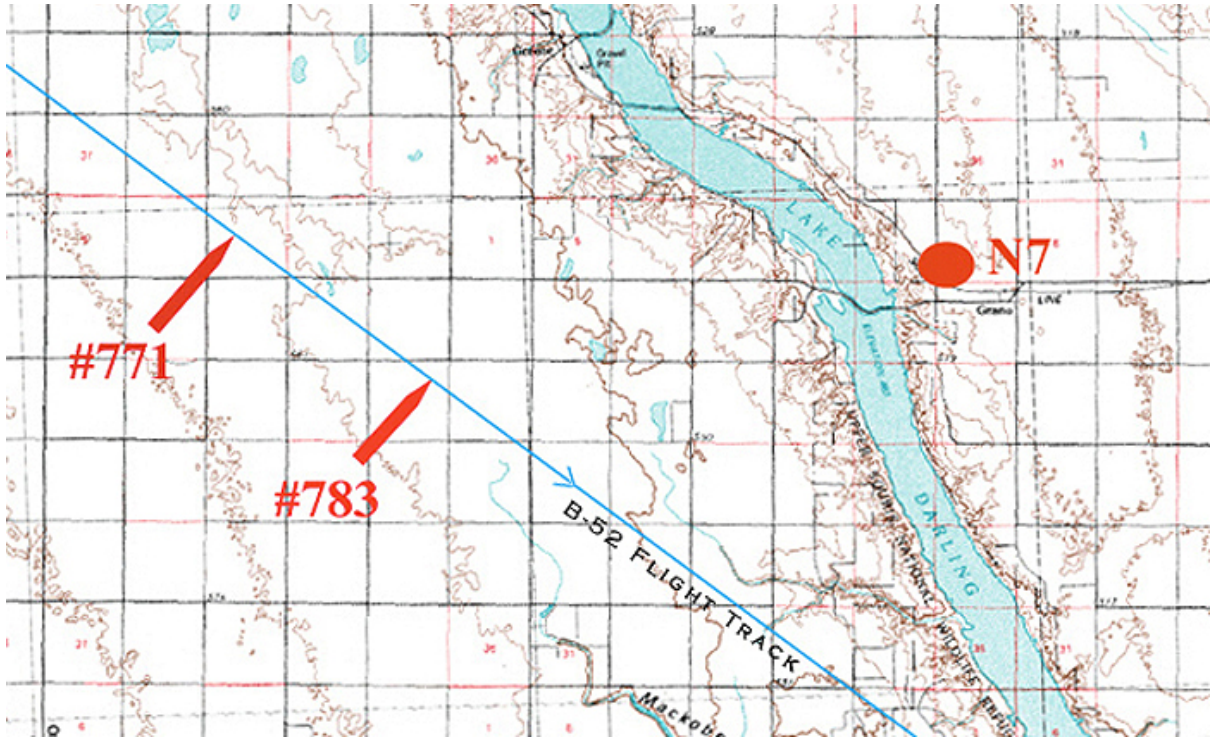

Figure 50. Position of the B-52 during photos 771 and 783. The USGS map grid is in statute miles.

altitude on the ground are quite distant from each other, which means that the ground is essentially flat along the 5 miles of the radar range. Now let us consider the vertical plane perpendicular to the B-52 trajectory, as seen from the rear of the aircraft. In Figure 51 we have reproduced the different altitudes of the B-52 from the different *hidden hypotheses* in Figure 47, except that in this instance we have the same vertical and horizontal scales. Five radar target directions are represented for the “Probable slope” trajectory. The length of the inclined lines, which join the position of the B-52 at 8865 feet MSL above the ground, measure exactly 5, 4, 3, and 2.5 nm. Finally, the altitude hole radius is a little less than 2 nm. The inclined altitude hole range hits the ground at a distance from the B-52 nadir that is not equal to the altitude hole radius of about 1.9 nm, but much closer at about 1.5 nm from the nadir. From this figure we can directly measure the tilt-up angle of the radar antenna:

- **A Tilt-up angle of 50° for the “Probable slope” trajectory**

- A Tilt-up angle of 45° for the “Minimum slope” trajectory
- A Tilt-up angle of 55.8° for the “Report slope” trajectory
- A Tilt-up angle of 71° for the “Maximum slope” trajectory.

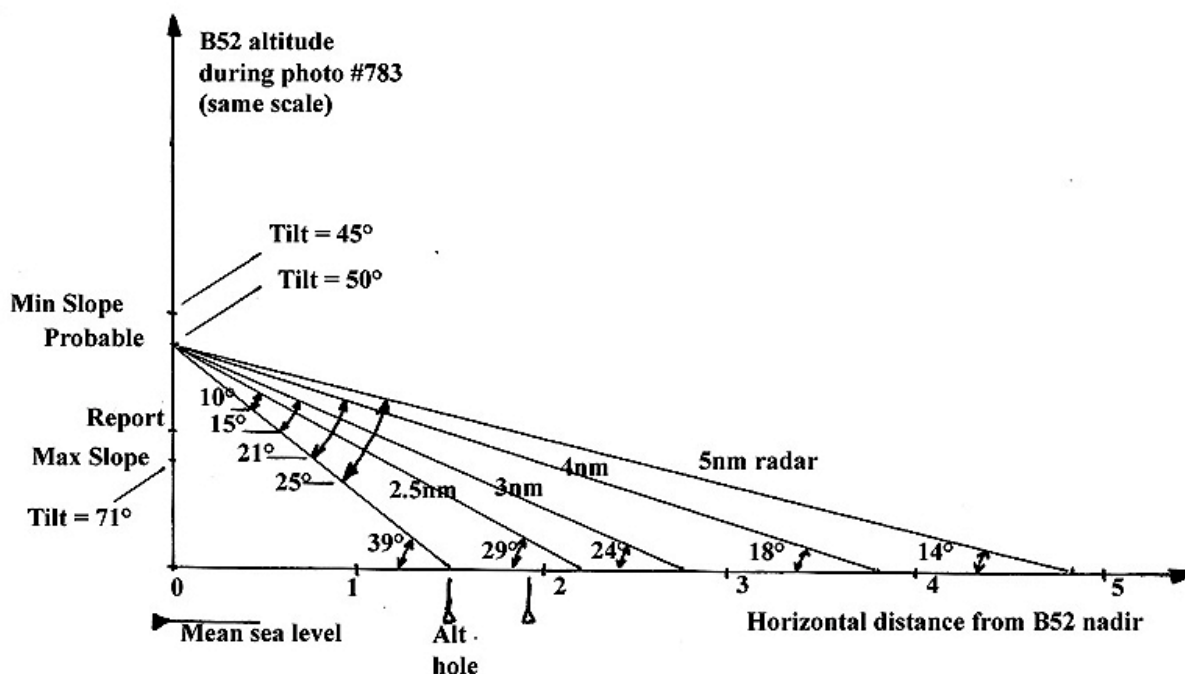

Figure 51. Vertical radar situation during photo 783. The B-52 altitude, and horizontal distance from the B-52 nadir are drawn at the same scale.

Thus, the tilt-up angle changes considerably depending on the possible B-52 trajectory *hidden hypotheses*. These hypotheses predict a possible trajectory for the B-52 from a theoretical point of view, and the “Probable slope” trajectory is based on aeronautical procedures that are plausible from a pilot’s point of view.

In Figure 51 the value of the α target angle is indicated for the different radar ranges for the probable trajectory hidden hypothesis:

- Angle $\alpha = 10^\circ$ for a 2.5 nm range.

- Angle $\alpha = 15^\circ$ for a 3 nm range.
- Angle $\alpha = 21^\circ$ for a 4 nm range.
- Angle $\alpha = 25^\circ$ for a 5 nm range.

There is another set of angles indicated in Figure 51, namely the *incidence* angle φ of the radar microwaves on the ground for different radar ranges:

- Angle $\varphi = 29^\circ$ for a 2.5 nm range.
- Angle $\varphi = 24^\circ$ for a 3 nm range.
- Angle $\varphi = 18^\circ$ for a 4 nm range.
- Angle $\varphi = 14^\circ$ for a 5 nm range.

This angle φ is significant regarding the microwave flux Φ_{ret} returned by the ground towards the radar, because this returned microwave flux varies as a function of the Φ_{in} incoming flux:

$$\Phi_{\text{ret}} = \Phi_{\text{in}} \sin^2 (\varphi) \quad (41)$$

The incoming flux is precisely the one defined by equation (40), divided by the square of the distance D :

$$\Phi_{\text{in}} = \Phi_{\text{max}} \sin (\varphi) / D^2 \quad (42)$$

The echo flux Φ_{echo} producing the radar signal painted on the radar screen is simply the returned flux Φ_{ret} divided by the square of the distance D :

$$\Phi_{\text{echo}} = \Phi_{\text{in}} \sin^2 (\varphi) / D^2 \quad (43)$$

If we take into account that the received flux is attenuated by the inclination of the antenna, the echo signal E_s received by the radar is:

$$E_s = k \Phi_{\text{echo}} \sin(\alpha) \quad (44)$$

Where k is the radar amplifier gain. This can be written:

$$E_s = k \Phi_{\text{in}} \sin^2(\varphi) \sin^2(\alpha) / D^2 \quad (45)$$

By replacing Φ_{in} by its value given by (42) we get:

$$E_s = k \Phi_{\text{max}} \sin^2(\varphi) \sin^2(\alpha) / D^4 \quad (46)$$

This is the *fundamental propagation equation of radar for the ground signal*, which is only valid if the antenna diagram is the one shown in Figure 48, which is yet another *hidden hypothesis*.

Let us calculate the non-constant terms of equation (46) for the angle values indicated for the “Probable slope” trajectory in Figure 51. Let us calculate \mathbf{Var} as follows:

$$\mathbf{Var} = \sin^2(\varphi) \sin^2(\alpha) / D^4 \quad (47)$$

For the different ranges D we get the following results:

- For $D = 2.5$ nm range, $\mathbf{Var} = 0.2768$.
- For $D = 3$ nm range, $\mathbf{Var} = 0.8976$.
- For $D = 4$ nm range, $\mathbf{Var} = 3.1395$.
- For $D = 5$ nm range, $\mathbf{Var} = 6.5332$.

Let us normalize these values for the 2.5 nm range, and call them $\mathbf{Var1}$, which simply means that we multiply these values by 3.613:

- **For 2.5 nm range, Var1 = 1.**
- **For 3 nm range, Var1 = 3.24.**
- **For 4 nm range, Var1 = 11.34.**
- **For 5 nm range, Var1 = 23.60.**

The **Var1** results indicate that if all our previous hypotheses are correct, the radar signal observed of the ground should be 23.6 times greater at a 5 nm range than at a 2.5 nm range. This theoretical result offers a simple, and neat checking method. However, in reality, we do not know the radar signal **Es**, but only the gray tone on a photograph of the radarscope.

Let us suppose that the radar system is completely linear and that the echo painted on the radar screen has brightness proportional to the signal **Es** calculated previously in (45) (another *hidden hypothesis*). In this case, the darkening of the image on the photographic negative film should be proportional to a function of **Es**. We know that a classical photographic emulsion gives a darkening (or % black grains) that is proportional to the *logarithm* of the brightness of the image. Let us calculate the logarithm of each of the previous **Var** values for each range, and call them **Var2 = log (Var)**:

- **For 2.5 nm range, Var2 = - 0.5578339**
- **For 3 nm range, Var2 = - 0.0469172**
- **For 4 nm range, Var2 = 0.4968605**
- **For 5 nm range, Var2 = 0.815126.**

Let us normalize these values for the 2.5 nm range, and call them **Var3**, which means we add to 1.5578339 to all values:

- For 2.5 nm range, Var3 = 1.000
- For 3 nm range, Var3 = 1.511
- For 4 nm range, Var3 = 2.055
- For 5 nm range, Var3 = 2.373.

These **Var3** results simply mean that if all our previous hypotheses are correct, *the photographic darkening observed for the ground should be 2.37 times greater at a 5 nm range than at a 2.5 nm range.* This is verifiable with photo 783. If we consider the positive-image band extending outwards from the B-52 nadir to the right side of radarscope photo 783, we see that the ground return contains signal variations.



Figure 52. Right side band of photo 783. This is a low-resolution (50 pixels per inch) scan of a Kodak Picturemaker photographic print of the original, sent by Tulien.

Fortunately, the radar operator had modified the radar screen brightness such that the ground brightness does not saturate the negative-image of the radarscope camera. This allows for a correct photometry of the ground region of photo 783. By measuring the percentage of black in this image we get the variation of the *real* logarithm of the radar screen luminosity along the different ranges, as presented in Figure 53. To avoid excessive noise, we average the values of the % black of three successive pixels. The altitude hole edge is 32% black, the middle is 85 % black, and the full white (B-52 nadir) is 0% black. Thus, most of our results are in the range 5 to

15% black. This means that the ground return brightness of the radar screen seems to have been such that the film is in its linear (log brightness) range of the photographic emulsion.

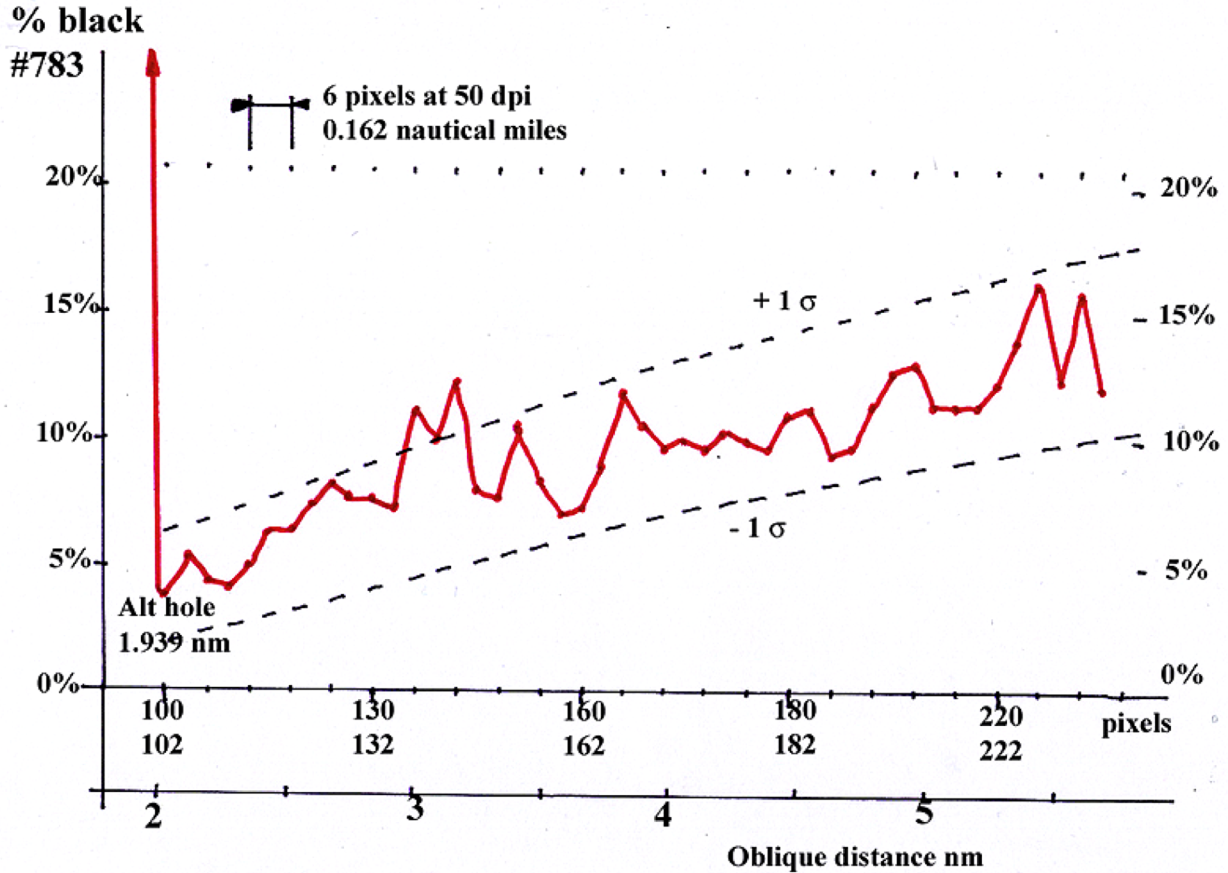

Figure 53. Real variation of the average photo darkening along a radius of Figure 52.

It is obvious from Figure 53 that the photo darkening for the ground radar return *increases* with the radar range, which is exactly what the previous method has predicted. Now let us look at the average darkening at 2.5 nm and 5 nm distances. This average value should be at the middle distance of the two curves ± 1 standard deviation ($\pm 1 \sigma$), obtained by calculating the square root of the average signal.

- For 5 nm = 12.33 % average darkening.
- For 2.5 nm = 5.33% average darkening.

- **The ratio is $12.33 / 5.33 = 2.31$.**

The theoretical value we should have found is **2.373**. The *real photometric result shows that the ground radar echo varies like it was predicted from the theory* with an accuracy of:

- **$(2.373 - 2.31) / 2.31 = 2.7\%$.**

This means that our three hidden hypotheses concerning the radar antenna diagram, the tilt-up angle of 50 degrees, and the B-52 “Probable slope” trajectory are correct. In fact, not only are these hypotheses confirmed with an overall accuracy of 2.7%, but other speculations seem to be accurate as well.

For example, ***the most probable B-52 descent trajectory is the one beginning at FL 200 at the WT fix ending at Final Approach Fix (MM) at an altitude of 3200 feet MSL.*** The distance traveled by the B-52 during this descent was 28.6 nm and its altitude decreased by 16800 feet; which means an *altitude change of 587.4 feet per nautical mile traveled horizontally.*

The most probable B-52 altitude during photo 783 was 8865 feet MSL. Since we measured a speed of 254 knots from radarscope photos 782 and 783, the horizontal distance traveled by the B-52 during the 3.0 seconds of each radar photo was 0.212 nm. That is, ***the most probable B-52 altitude change during each radar photo was 124.34 feet.*** We can now calculate the B-52 altitude at the end of each radar photo by adding this change to the altitude of the subsequent photo:

- **Photo 783: altitude = 8865 feet MSL**
- **Photo 782: altitude = 8989 feet MSL**
- **Photo 781: altitude = 9114 feet MSL**
- **Photo 780: altitude = 9238 feet MSL**

- **Photo 779: altitude = 9362 feet MSL**
- **Photo 778: altitude = 9487 feet MSL**
- **Photo 777: altitude = 9611 feet MSL**
- **Photo 776: altitude = 9735 feet MSL**
- **Photo 775: altitude = 9860 feet MSL**
- **Photo 774: altitude = 9984 feet MSL**
- **Photo 773: altitude = 10108 feet MSL**
- **Photo 772: altitude = 10233 feet MSL**
- **Photo 771: altitude = 10357 feet MSL.**

In order to determine the ground altitude of the B-52 we can subtract 1823 feet from the previous values. We find for photo 771 a ground altitude = $10357 - 1823 = 8534$ feet, which corresponds to 1.405 nm ground altitude. With a tilt-up angle of 50 degrees for the radar antenna we should have:

- **Altitude hole radius 771 = Ground altitude 771 / Cos(50°)**

We find the following value:

- **Altitude hole radius 771 = 2.19 nm.**

The actual altitude hole radius measured on photo 771 is 2.2 nm, which is the same value with an accuracy of 0.65 %. *Therefore, the tilt-up angle we used in the analysis report (55.8 degrees) is not the most probable value of 50 degrees.* Does this mean that we have to recalculate all values depending on the antenna tilt angle? There is more than that to do because

this photometric study of the ground echo has presented several other hypotheses, which will be examined later in the second discussion section, entitled, **5-10. Discussion 2: Photometric Study and the Ionized Cloud Surrounding the UFO.**

Part 5. The Ionized Cloud Surrounding the UFO

5.1. The Air-Visual UFO Observation from the Perspective of the B-52

According to the descriptions of the pilots, the B-52 executed a 90-degree left turn onto the base leg at the point where it was closest to the UFO on or near the ground. At this time the B-52 was at 3200 feet altitude (MSL), or about 450 meters (1500 feet) above the ground, and its speed was 180 knots (92.6 m/s). We can assume that pilot Major Partin, seated on the left side of the cockpit, centered the turn over the UFO in order to better observe it. This would place the UFO at the focal point to the axis of the wing and in front of the left lateral windows of the cockpit.



Figure 54. Two views from copilot Capt. Runyan's perspective looking across the B-52 cockpit. Runyan viewed the UFO on or near the ground through the pilot's windows during the 90° left turn to the base leg.

A turn made at the standard rate of 180 degrees per minute corresponds to a turn radius of 20 seconds of flight, which is 1852 meters (1 nm). We can multiply 20 seconds by π (3.14) to arrive at 63 seconds for a 180-degree turn. Therefore, the duration of a 90-degree turn performed at this standard rate is 30 seconds. However, copilot Runyon reported having observed the UFO across the cockpit through the pilot's windows for only about 10 seconds. This suggests that Partin performed the turn much closer to the UFO and with a larger incline than would be normal for a standard turn.

Let us call R the turn radius. The distance traveled by the B-52 in the course of the 90 degree turn is simply $\pi R / 2$, and the time (T) needed to go through this distance is $T = \pi R / (2 \cdot 92.6) = 10$ seconds. We can easily deduce that $R = 590$ meters. The distance D separating the pilots from the UFO in these turn conditions is resolved by:

- $D^2 = (450)^2 + (590)^2$, which gives: $D = 740$ meters (2428 feet).

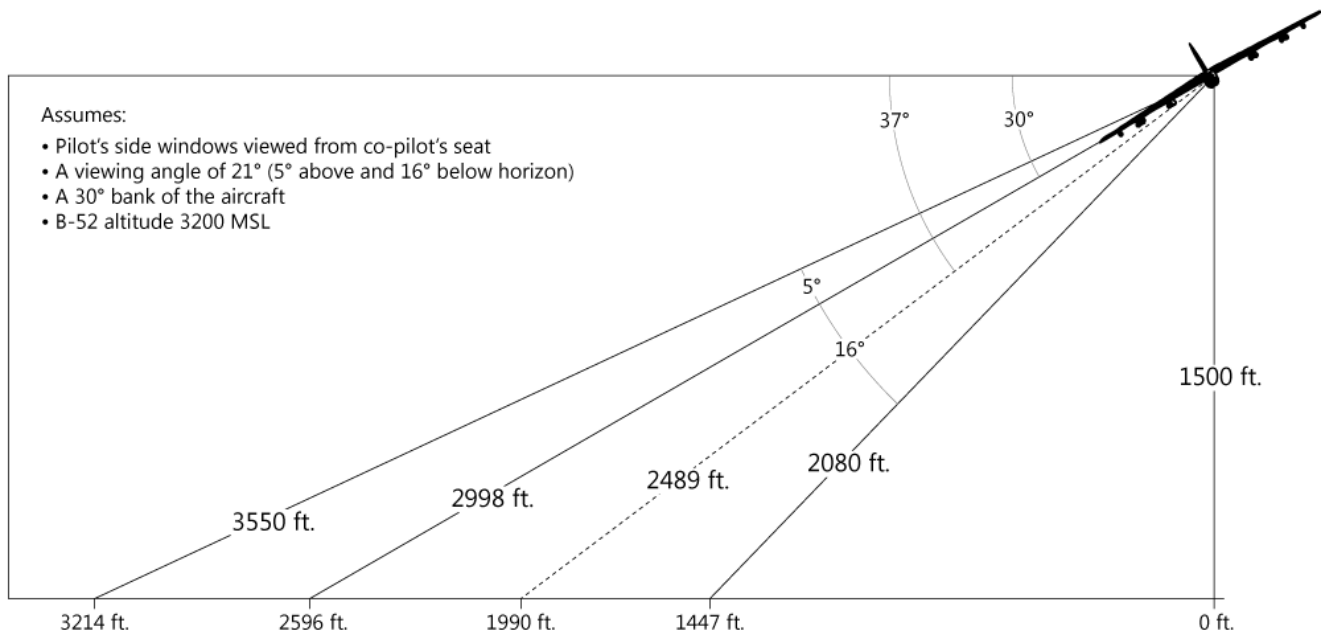

Figure 55. Hypothetical 30-degree bank angle during the left turn onto the base leg.

However, such a steep turn is not possible for a B-52 at low speed (180 kts). We must concede that both pilots could not have observed the UFO throughout the entire turn (30 seconds), but only for about one third of the total duration (10 seconds) with a necessary turn radius of about one nm. This observational turn was centered in order to pass as close as possible over the top of the UFO. The trajectory is quite compatible with the recollections of the witnesses, concerning its duration and timing. For example, Runyon recalls:

I would probably put ten seconds in the range because we flew down the side of it for about two or three, maybe four seconds. . . . Major Partin started his turn just as we got abreast of the end of it and turned almost over the top of the thing. I'm sure we were told to turn by the [radar] ground controllers so they knew exactly where we were in relation to it.²⁰

5.2. Dimensions of the UFO According to B-52 Pilot Partin

In accordance with our previous calculations, the incline of the airplane would have been:

- **Incline = Arc Tg (450 / 590) = 37 degrees.**

This is a significant angle of incline for a B-52 at low speed during approach. At such an angle, the weight of the plane multiplied by the load factor (caused by the centrifuge force) must be compensated with a corresponding lift increase during the turn. In this instance, the load factor would have reached 1.26 g, making it necessary to augment the lift by 26% in comparison with horizontal flight. As a result, even if the incline of the B-52 was less, we can assume that Partin paid close attention to the controls of the aircraft, which would only allow stealthy looks towards the UFO. However, in his official report, he made two drawings of what he saw. His first drawing is a circle representing an orange ball of light with an oval ring of soft white light extending to the right side in which the ratio of the axes is 3.7.

²⁰ Runyon, Bradford, Jr., 2005. Interview by Thomas Tulien, 25 February (Sign Oral History Project), 15-16. Available from: http://www.minotb52ufo.com/interviews/runyon2005/runyon2005_pg15.php.

5. The Ionized Cloud Surrounding the UFO

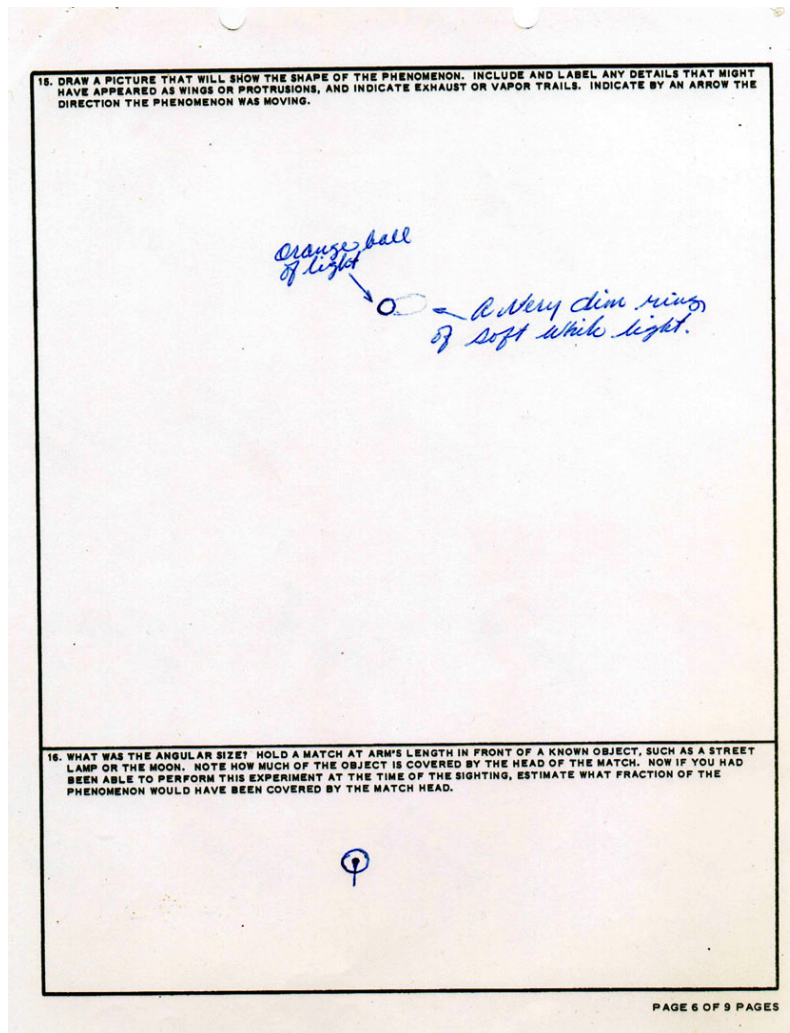

Figure 56. Two drawings by B-52 pilot James Partin in his AF-117, dated 30 Oct. 1968. Available from: <http://www.minotb52ufo.com/pdf/0024.pdf>. In a 2001 interview, he recounted that at 1500-1700 feet altitude a house on the ground appeared to be about the size of a die, or a Monopoly house, and the UFO appeared to be much larger than that. Interview available from: <http://www.minotb52ufo.com/interviews/partin2001/partin2001.php>.

His second drawing features the angular diameter of the orange ball of light by estimating what fraction of the visible phenomenon a match head would have covered at arm's length. The drawing indicates that its diameter, as seen from the B-52, was 4 times the width of the end of match (4 mm) held at arm's length (60 cm). We can deduce that the angular diameter, expressed in radians, was $1.6 / 60$. When we multiply this by the probable distance of calculated

observation at 740 meters (2428 feet), we get the following dimensions of the orange ball of light:

- Diameter of the UFO = $1.6 \cdot 740 / 60 = 20$ meters (65 feet)
- Length of the UFO = $20 \times 3.7 = 73$ meters (240 feet).²¹

5.3. Dimensions of the UFO According to B-52 Copilot Runyon

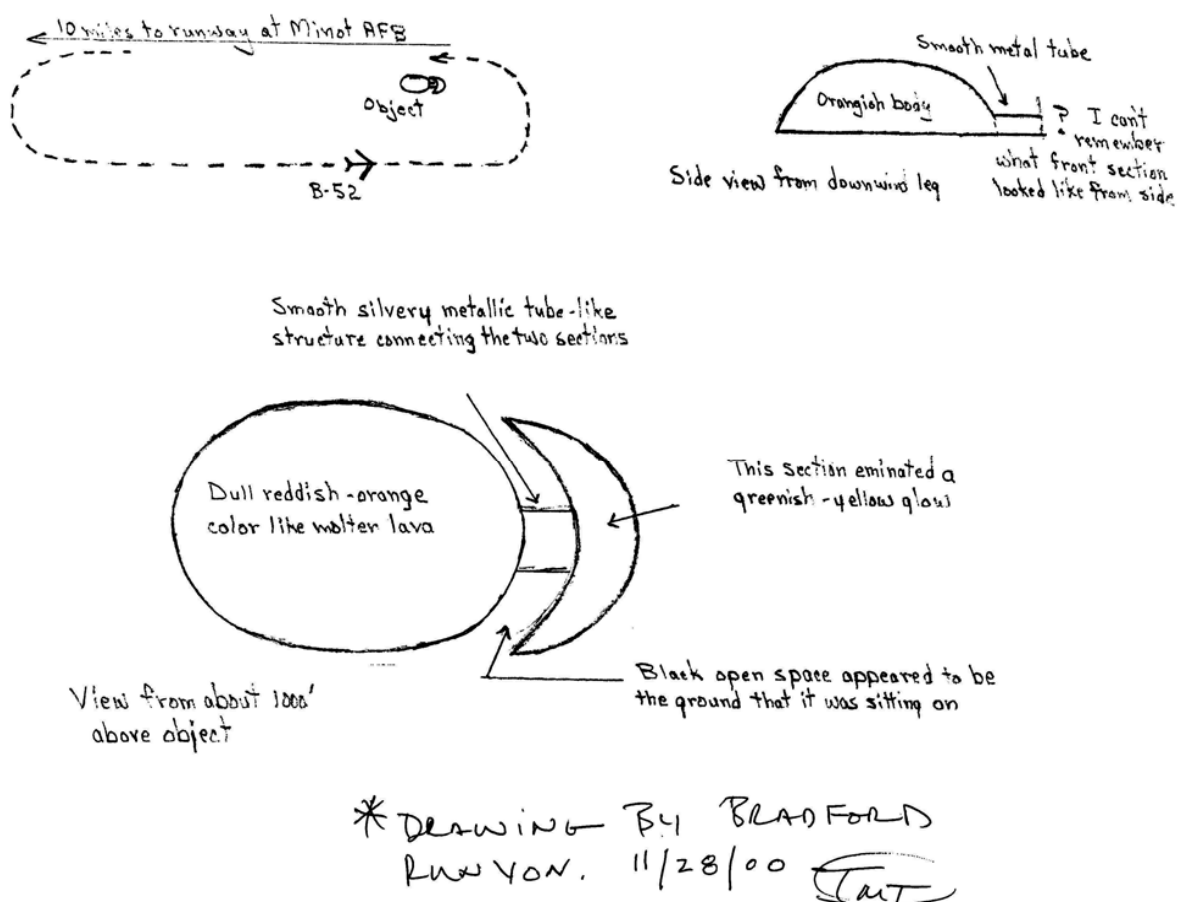

Figure 57. Drawings of the UFO by copilot Bradford Runyon made in November 2000. He cautiously estimated the dimensions to be: 200 feet (60 meters) in length, 100 feet (30 m) in width, and 50 feet (15 m) in height. Project Blue Book investigators did not interview Runyon in the course of the official investigation.

²¹ In his AF-117, Partin states that he “turned onto the base leg one mile South of the light and was above it” (4). If statute miles, this would change the diameter to: $1.6 \cdot 1609 / 60 = 43$ m (141 feet). If nautical miles it would change the diameter to: $1.6 \cdot 1852 / 60 = 49$ m (160 feet).

During the downwind leg of the traffic pattern, copilot Captain Bradford Runyon completed the various landing checklists, and not being solely responsible for piloting the aircraft, would have been in the better position to view the UFO throughout the 90-degree turn.

In Runyon's estimation, the UFO measured about 200 feet (60 meters) in length, 100 feet (30 m) in width, and 50 feet (15 m) in height. The dimensions estimated by the two pilots are relatively close, considering the brevity of their observation (10 seconds). Both estimated the dimensions by comparison to houses and farm buildings. For example, at first Runyon thought he was seeing the side of a barn; whereas Partin affirmed the UFO was much larger than a house.

In addition, Partin provided angular dimensions, which allow us to calculate the real dimensions according to the reconstruction of the trajectory of the B-52. It is unlikely that the similar dimensions are chance, since these are seasoned professionals specifically trained in the recognition of targets during a penetration at low altitudes under any conditions. In addition, the visibility close to the ground was unobstructed for 25 miles. Thus, both pilots were able to clearly view the object.

5.4. Dimensions of the UFO According to the Radar Echo

The radar onboard the B-52 provides its own unique description of the UFO and its movements, which are preserved for analysis by the consecutive radarscope photographs. In this case, these photographs are first-generation prints from the original negative film of the B-52 radar camera, a copy of which were retained by the 5th BMW intelligence officer SSgt. Clark at Minot AFB. We can enlarge the image since it was scanned with a resolution of 300 pixels per inch (dpi) from the original 8 X 10 photographic print.

Here is the central region referred to as the "TR (transmit/receive) hole," or "altitude hole" of photo 773:

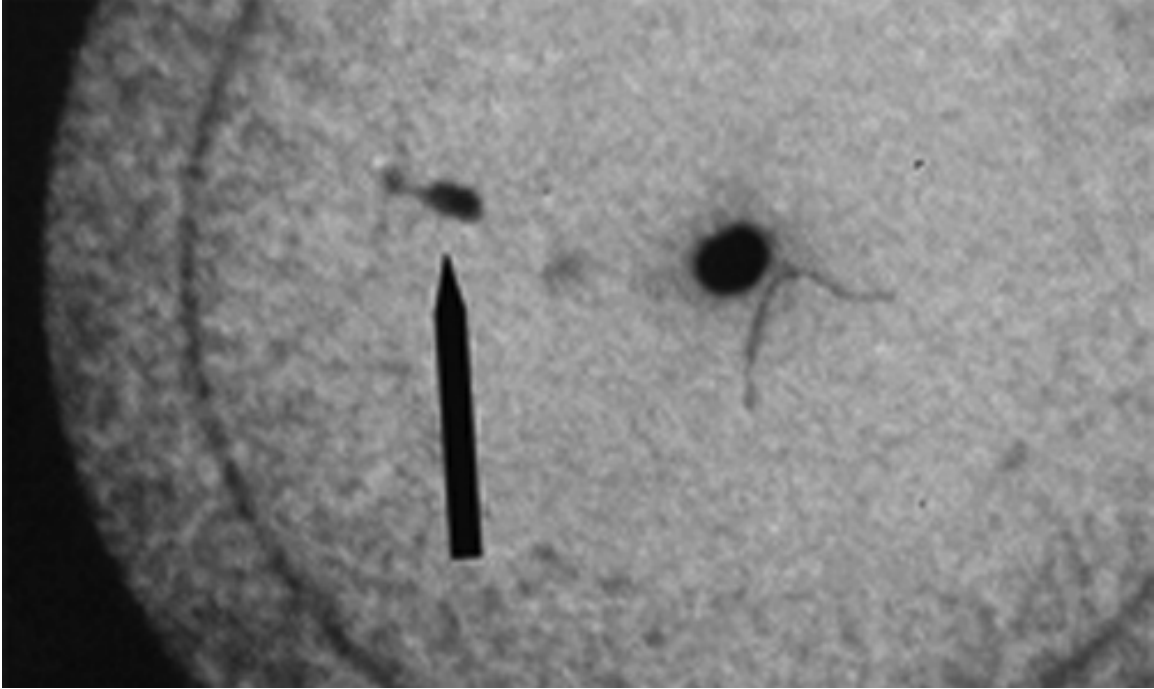

Figure 58. The radar echo of the UFO in radarscope photo 773 (negative image).

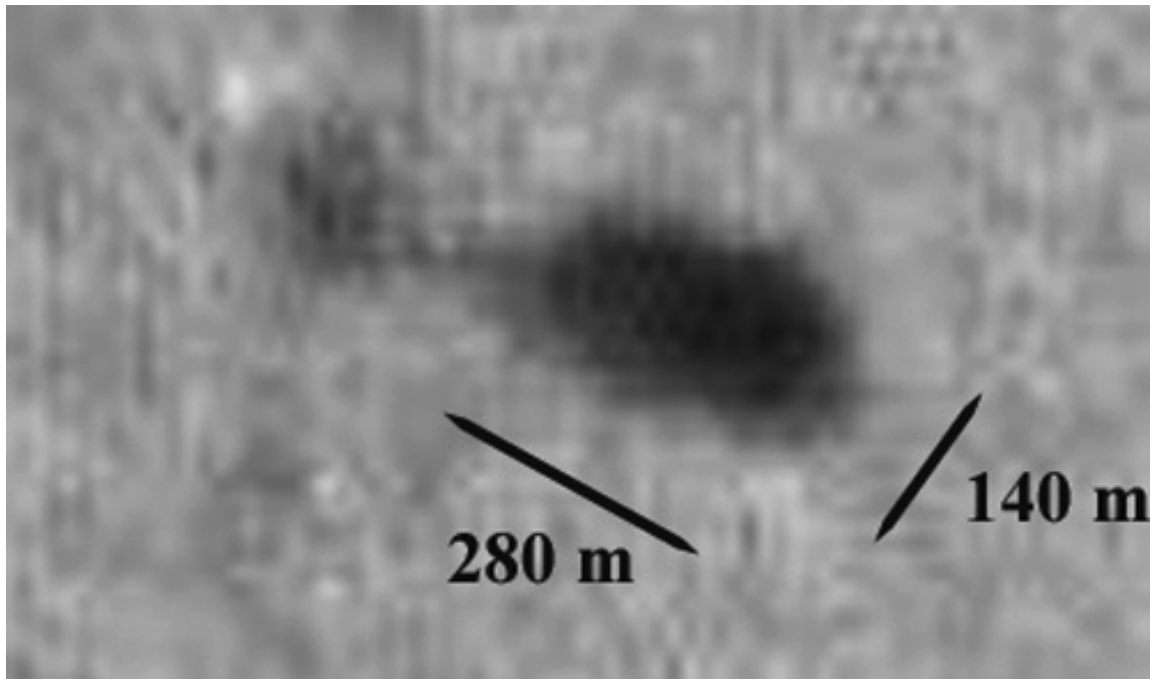

Figure 59. Enlargement of the UFO echo. (280 m = 920 feet; 140 m = 460 feet).

Since the B-52 radar allows us to establish distance with accuracy in the order of 30 meters, we have an idea of the considerable size of the echo of the UFO. The main body of the

echo has a length in the order of 250 / 280 meters (820 / 918 feet) and a width in the order of 140 meters (459 feet). Towards the left of the main body of the UFO there appears a barely resolved *bridge* more than 150 meters (492 feet) long, and a second, poorly resolved body in the order of 100 meters (328 feet) diameter. A specific software program allows us to illustrate the outline of the echo by defining the perimeter of the object at the threshold of the atmospheric background.

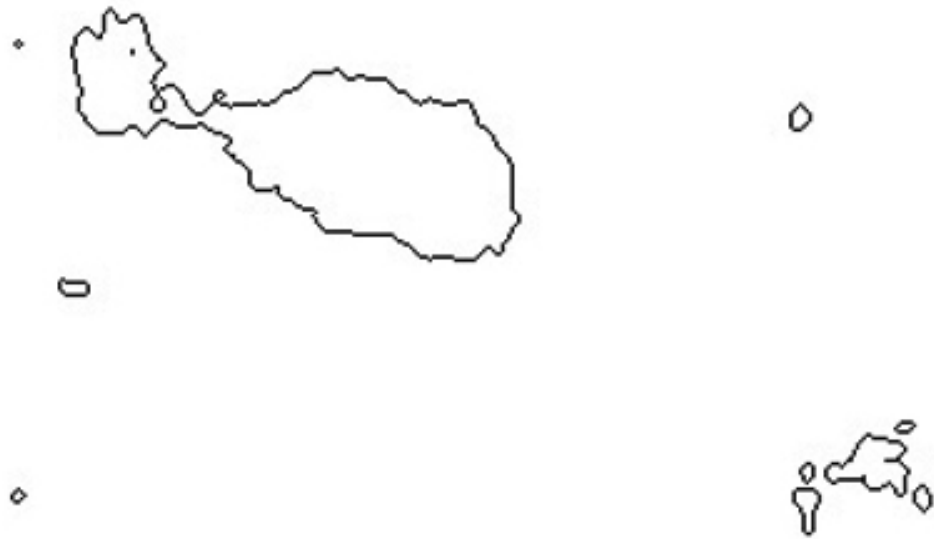

Figure 60. Outlines of the threshold of the UFO echo in photo 773.

In the outline, we see the general shape of the echo captured by the radar. This shape is similar to the drawings of the object by Captain Runyon at a distance of approximately 740 meters (2428 feet). However, both pilots estimated the dimensions of the object to be about a quarter of those that are measured by this radar echo. Let us examine this discrepancy in more detail. A more detailed analysis, which outlines the photographic darkening with various

thresholds of intensity in false color, reveals a variable density of the echo from its edges to its center.

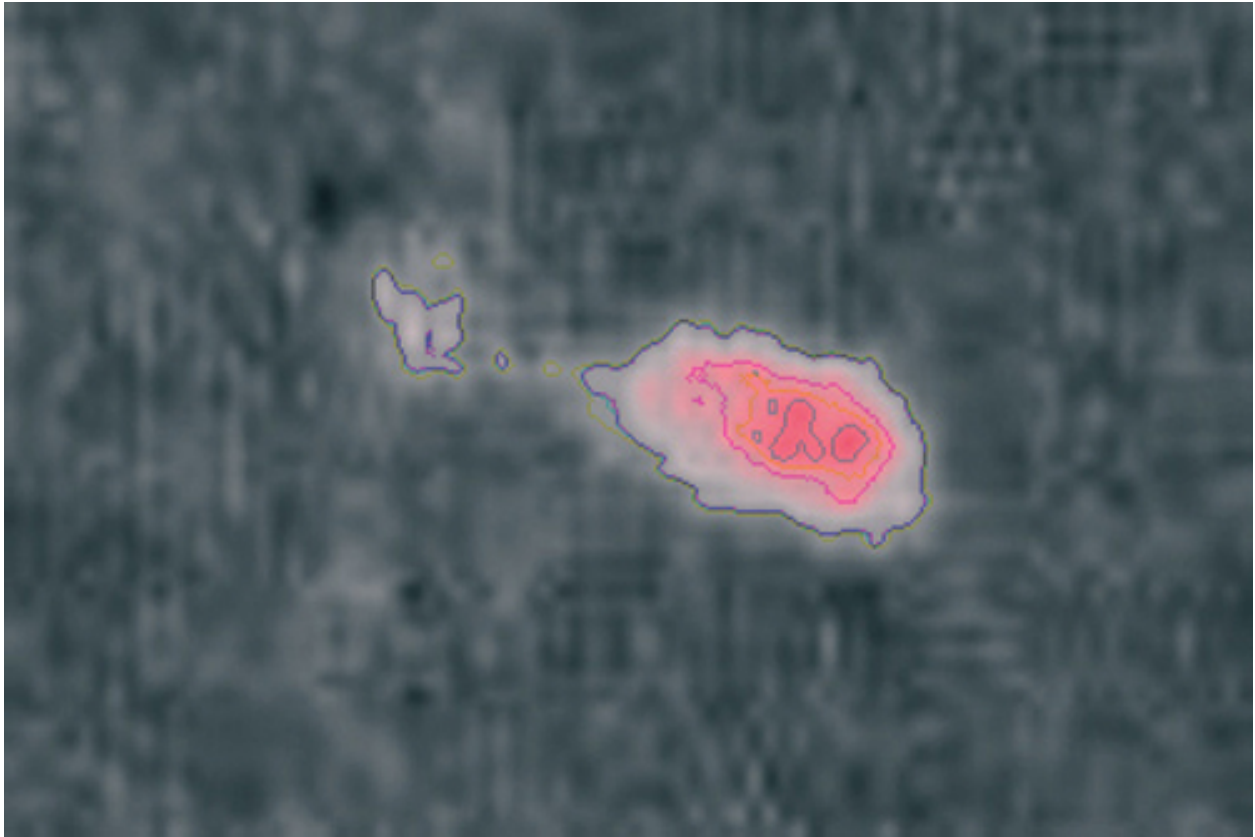

Figure 61. Outlines of various thresholds of the UFO echo in photo 773.

We can conclude from the previous figure that the echo does not appear as though the return of the radar waves were the result of a metallic surface having the equivalent dimensions as the echo. It seems that the reflection coefficient (i.e., the radar *albedo*) increased as more microwaves entered inside the volume of the echo. What the radar “paints” on the scope is actually the intensity of the microwave signal returned by the target, rather than the actual target itself. Therefore, we must examine the properties of electromagnetic wave propagation while being as concise as possible.

5.5. Using Theoretical Physics to Explain the Luminous Halo Phenomenon

In many cases, when UFOs are observed in nocturnal conditions witnesses report that they are surrounded by an intense luminosity, often as a function of extreme acceleration. Over the course of 30 years of theoretical physics studies, I have been able to demonstrate that the phenomenon is actually a secondary atmospheric effect caused by the propulsion field of the UFO.

My *Universons' theory* hypothesizes that the effect is a result of a quantified gravitational field that interacts with elementary particles of matter, called *Universons*. These Universons consist of a natural energetic flux containing kinetic momentum. This theory explains inertia and gravitation, provided that Universons have a particular behavior (an assumption that will not be explored in this present study).²²

Universons' theory also postulates the existence of a constant *cosmological acceleration*, which would be added to any accelerated matter as a result of the expansion of the Universe. In fact, this cosmological acceleration has apparently been observed by NASA-JPL in the trajectory of the interplanetary space probes Pioneer 10 and 11. The same cosmological acceleration also explains remarkably well an astronomical mystery observed by Edwin Hubble in 1950, specifically the *constant orbital speed of stars*, a speed that occurs independent of the orbital radius in galaxies. Therefore, we have several *observational confirmations of the scientific predictions of Universons' theory*.

The application of the natural flux of Universons could theoretically be applied to numerous applications, particularly to *propelling space vehicles*. For example, if it were possible

²² See: <http://www.universons.com/>

to control the trajectory of Universons re-emitted naturally by the matter of the vehicle, we could create inertia in an entirely unique way. Further, theoretical studies have revealed how such a propulsion method would permit the same ***acceleration for all elementary particles of the matter associated with the spacecraft, including the occupants***, thereby eliminating the disadvantages of inertial effects and particularly the mechanical constraints linked to acceleration. In other words, these studies show that this type of propulsion would be able to produce considerable acceleration of the vehicle (several hundred g) without vital risk to the passengers.

Given these conditions, the vehicle could attain a relativist speed within a short time period. In effect, at 600 g acceleration the speed would be 93 % of the speed of light in 13 hours. If the speed of the vehicle becomes relativistic, we know that the ***onboard clock*** would decelerate considerably in comparison with the clock located on the planet of departure. In this case, the lifespan of the occupants of the vehicle would not be a limit to the surmountable distances, since the vehicle could travel between all points in the Galaxy ***during the lifetime of the occupants***.

The only theoretical limitation in an interstellar voyage using this mode of propulsion would concern energy. However, ***the energy onboard the vehicle could theoretically be extracted from the natural field of the Universons***. There are numerous natural examples where such extraction of energy is accomplished, including the kinetic energy of the solar system orbiting around the Galactic center. [Our kinetic energy is 30 billion joules per kg of matter, including the matter with which our human bodies are composed]. Therefore, these theoretical considerations are reinforced by the results of astronomical observatories and space

trajectography data stations, and present a novel scientific status in the practicability of an interstellar voyage by intelligent beings.

In addition, these theoretical studies reveal very particular characteristics of vehicles with this type of propulsion. Let us assume that these characteristics are precisely those described by witnesses who have observed UFOs for decades. The two primary theoretical characteristics of these observations are the ability for stationary flight, or in very powerful acceleration with an absence of a sonic boom in spite of a supersonic speed in the dense atmosphere, and the presence of a bright atmospheric halo that encompasses the vehicle.

5.6. The Luminous Halo Encircling the UFO

With regard to the unidirectional flux of Universons, a propelling flux that is able to push equally on all elementary particles of the UFO would result in all of the electrons of the atoms being subjected to unidirectional acceleration as a result of the field, which is vectorially added to the acceleration caused by the electric attraction of the nucleus. This effect is not limited to the vehicle's atomic structure, but also includes the atmospheric air encircling it. That is, the atoms of atmospheric gas are also subjected to the significant pressure of this propulsive flux. Given these conditions, we would likely observe a significant distortion of the electronic orbits in the atoms constituting the gases of the atmosphere. This orbit would adopt an oblong shape under the influence of the external propelling field not unlike a rugby ball:



Figure 62. In a constant external propelling field, the electronic orbits of atoms are distorted, creating a negative space charge where the orbits are most distant from the nucleus.

Naturally, the more distant the atoms of gases are from the UFO, the less intense the phenomenon. However, close to the UFO the propelling flux would be so intense that it can tear off one or more electrons from the atom, especially during strong acceleration. The propelling flux partially *ionizes* the air encompassing the UFO. The free electrons collide with other atoms in the pressure that exists at ground level, where the densities of atoms are $2.65 \cdot 10^{25}$ per cubic meter. Of course, the free electrons are particularly attracted to the positive *ions* that have lost one or more electrons earlier. Therefore, we have a double phenomenon. On the one hand, we witness an *extraction of electrons* in the gas due to the propelling field, and on the other hand, we observe *a recombination of electrons* with ions.

The recombination of electrons is accompanied by an *emission of photons of light*, which is essentially the way light is produced in nature. Another term for this process is *radiative recombination* in which the emitted photons of light have a characteristic color depending on the type of ionized atoms in the atmosphere (i.e., nitrogen, oxygen, carbon dioxide, xenon) and the kinetic energy of the liberated electrons. Curiously, the colors of the radiative recombination photons of the atoms constituting the atmosphere of the Earth are in our case *exactly what the*

ground witnesses described. However, our concern is not the light issued by the atoms of partly ionized air encircling the UFO, but rather, the behavior of radar waves in this partly ionized gas.

5.7. The Behavior of Electromagnetic Waves in Ionized Gas

When electromagnetic waves began to be used for radio communications over large distances, a fluctuating phenomenon referred to as *fading* was observed. Fading is caused by a reflection of the waves on an agitated layer of gas in the ionosphere. As a result of ionospheric reflection, it was possible to communicate by radio with antipodes in a series of successive rebounds of the wave between the conductive ionosphere and the ground of the Earth. In the beginning, radio waves were very long, prior to the advent of electronic tubes, which allowed the generation of high frequency waves and amplification of the reception.

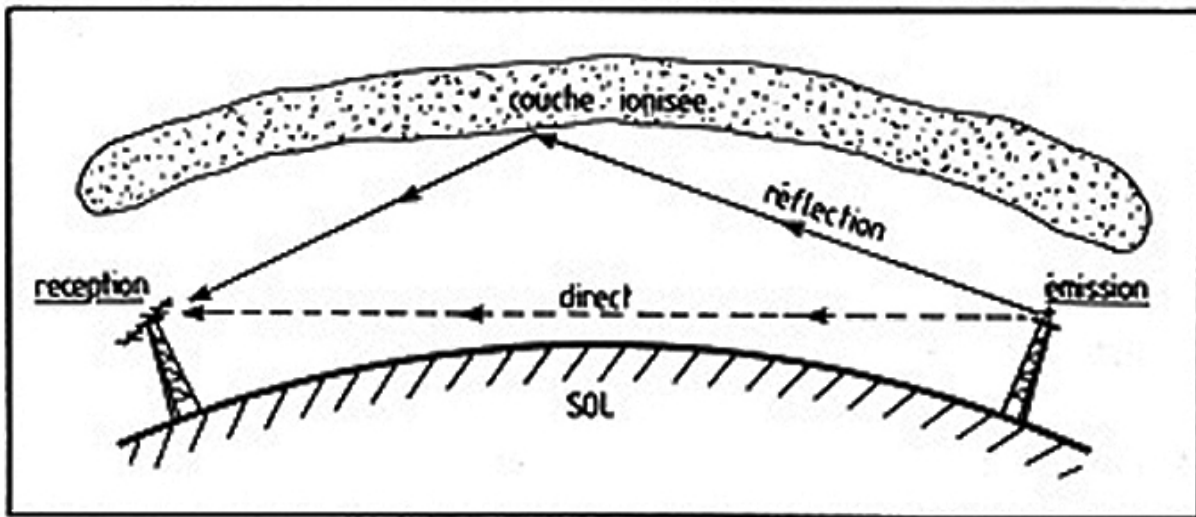

Figure 63. The electromagnetic waves reach the reception antenna by two separate interfering paths. One by direct propagation in free space, and a second reflected on the agitated ionosphere.

The ionosphere acts as a mirror only for electromagnetic waves lower than a *critical frequency*. When the emitted frequency $F1$ is *larger* than critical frequency Fc , the wave is simply transmitted through the ionosphere and nothing is returned. When emitted frequency $F2$

is *smaller* than F_c , the wave is reflected completely and returned to the receiver. This effect is used every day by short wave band communications; in the study and prediction of ionospheric conditions; and scientific research to understand the plasma physics of the solar-terrestrial interaction of the Earth's atmosphere and magnetic field with the solar wind.

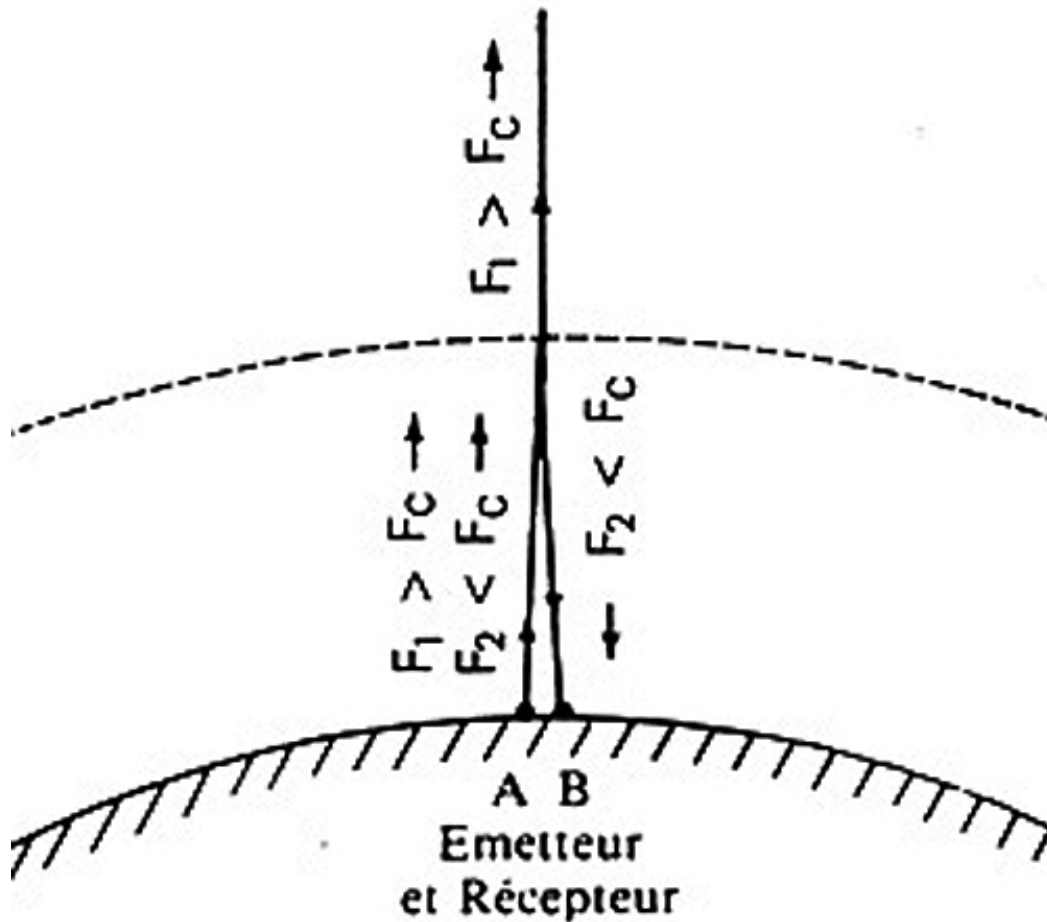

Figure 64. Principle of an ionospheric sounder constituted by a transmitter and a receiver placed very close, sending and receiving pulsed radio waves in the vertical direction

F_c changes according to local time and from one day to the next, due to natural conditions. In effect, it is such that:

$$(2 \pi F_c)^2 = N e^2 / \epsilon_0 m_e \quad (48)$$

In this expression, e is the charge of the electron, m_e its mass, ϵ_0 is the dielectric constant of vacuum, and N is the average number of free electrons per cubic meter in the ionosphere. Basically, we use the following equation:

$$F_c^2 = 80.7 N \quad (49)$$

As a result:

$$N_c = 0.0124 F_c^2 \quad (50)$$

Relation (50) allows us to determine the average electronic density (free electrons per cubic meter) of the ionosphere by measuring the critical frequency. The ionosphere is a vacuous region of the upper atmosphere from 60 to about 1000 km in altitude. At this altitude the ultraviolet photons of light from the sun are not entirely absorbed by the molecules of gas, as is the case in low layers of the atmosphere. In fact, these photon rays are able to tear off electrons from the atoms of gas. However, the density of gas is weak and the free mean path of an electron is very large. Thus, the amount of electrons that are *recaptured* by the ions is significantly reduced in high altitudes compared to low altitudes. The gas is therefore a mixture of positive ions and free electrons of an electronic density N .

Of course, at night, there are no solar ultraviolet photons. Therefore, electronic density drops quickly at sunset. Further, according to seasonal changes, the ultraviolet rays are more or less tipped-up in comparison with the zenith, affecting the degree of ionization. Finally, the amount of ultraviolet rays reaching earth is variable according to changing solar activity. The electronic density N , and consequently F_c are therefore varying phenomena. F_c can in fact vary by a factor of 4 between day and night in winter, and by a factor of 2 between day and night in

summer. It also varies altitudinally throughout the successive layers of the ionosphere. Generally, the critical frequency of the ionosphere varies from 3 to 15 MHz according to location and time of day. Therefore, the ionized gas, sometimes called *plasma*, has specific properties that deviate electromagnetic waves. Its index of refraction is larger when the specific density of the free electrons N is also larger. Consequently, the path followed by the electromagnetic waves is curved, because the electronic density varies vertically.

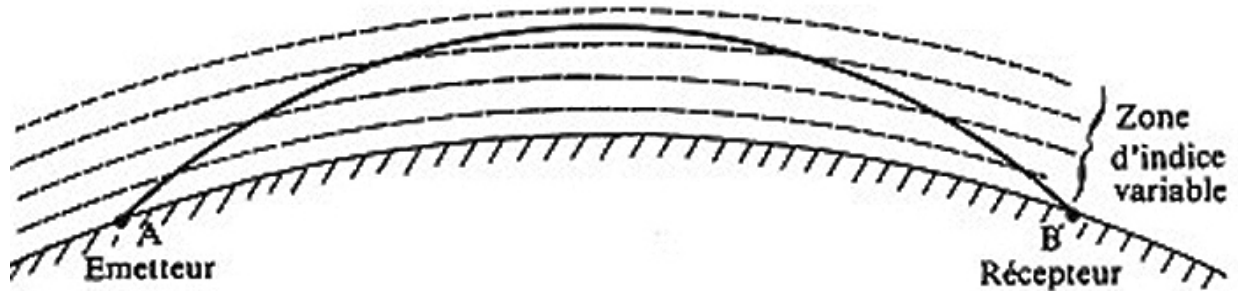

Figure 65. By crossing successive layers of variable refraction index the EM waves are deviated following a curved path.

For waves having less than the critical frequency, if the curvature angle of the path attains 180 degrees the wave returns to its starting point. Therefore, *the critical frequency is the one for which the electromagnetic wave is completely reflected by the ionosphere*. Space research and exploration that operates above the ionosphere utilizes communication and telemetry frequencies greater than the critical frequency, which is one of the reasons why space telecommunications use frequencies of several gigahertz. However, even when we use frequencies superior to the critical frequency of the ionosphere to communicate with artificial satellites in orbit there are always deviations of the waves caused by the ionosphere.

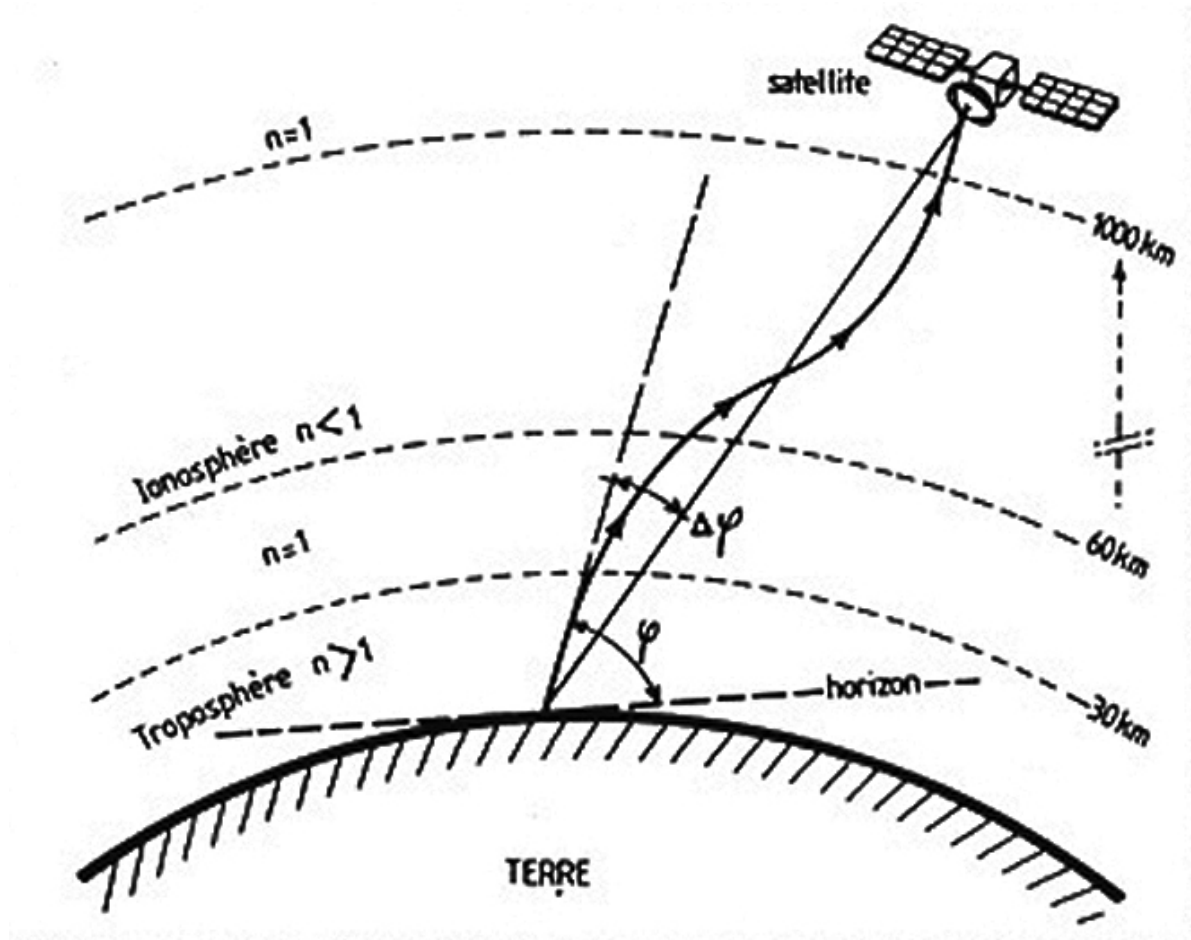

Figure 66. When we want to communicate with an artificial satellite by means of a very directive beam of radio waves we need to take into account the ionospheric refraction, which deflects the electromagnetic waves path.

These considerations of ionospheric deviations of the electromagnetic waves are quite significant as we are about to see.

5.8. The Effect of Air Ionization on Radar Waves

The electronic density of the ionosphere would be significantly less than the atmosphere encompassing a UFO in flight. In this instance, the ionization of gas is not caused by the interaction of ultraviolet photons, but rather by the pressure of the flux of Universons that augment the lift and acceleration of the UFO. Consequently, *the ionization is so intense that the*

luminosity emitted by the atmosphere is considerable, particularly during a powerful acceleration of the UFO. Theoretical physics allows us to calculate the intensity of the light emitted according to the propelling flux. In this instance, the ground observers at Minot AFB are unanimous in describing a very large UFO, which alternated color from a very bright white to orangish-red and green. It would seem the rate of ionization of air encompassing the UFO was considerable.

Certainly, we do not know how to reproduce such levels of ionization of air at an atmospheric pressure of 1 bar. However, we can extrapolate experimental and theoretical knowledge at lower pressures in the ionosphere. We know that the B-52 radar transmitted pulses at a frequency of about 9000 MHz. We can therefore extrapolate the complete reflection of these radar waves and their corresponding electronic density. In order to accomplish this task, let us apply $F_c = 9000$ MHz to equation (50):

$$N_c = 0.0124 F_c^2 = 0.0124 (9 \cdot 10^9)^2 \quad (50 \text{ bis})$$

We get:

- $N_c = 10^{18}$ electrons per cubic meter.

At the time of the radarscope photos, the B-52 was at an altitude of 3000 meters MSL. On average, we know that at this altitude the atmosphere contains $1.9 \cdot 10^{25}$ molecules or atoms per cubic meter. As a result, the calculated ionization (compare this content with N_c) is only partial and concerns one ionized atom per 19 million. However, this feeble ionization rate is theoretically sufficient to completely reflect a radar wave of 9000 MHz and to return an echo as intense as the ground echo beneath the B-52. Here then is the probable schema of what took place at Minot on 24 October 1968:

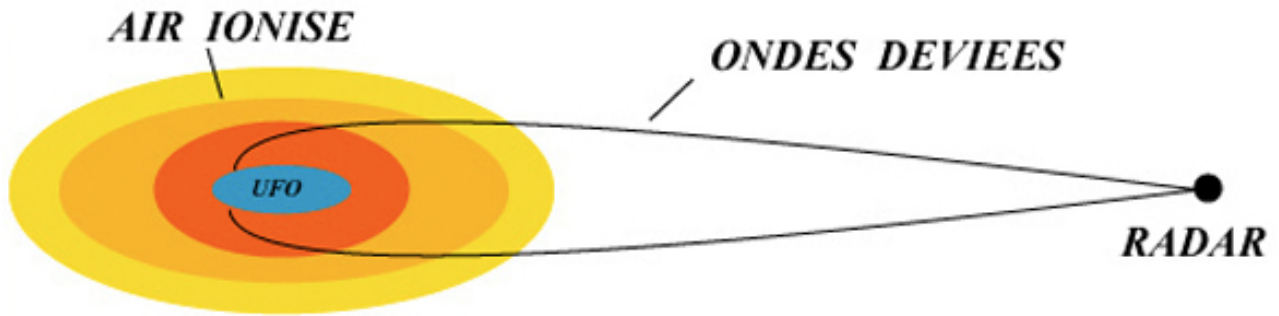

Figure 67. A zone of highly ionized air, which emits a powerful diffuse light encircling the UFO. The electronic density in the UFO halo is such that in the partly ionized gas the radar waves are strongly deviated, even completely reflected. (AIR IONISE = ionized air. ONDES DEVIEES = Deviated waves).

The schema of the previous figure demonstrates that lateral radar waves, which should normally not attain the reflective surface of the UFO, are in fact highly deviated and return to the radar in such a way that they augment the apparent size of the radar echo compared to the witness estimates. The radarscope photographs are an interesting confirmation of our hypothesis, since they allow us to determine the order of magnitude of the minimal electronic density that existed in the air encompassing the UFO (about a billion-billion electrons per cubic meter), as well as the proportion of atoms ionized (about one atom ionized for 19 million atoms remaining neutral).

5.9. The Loss of VHF Transmission

The dimensions of the radar echo (280 x 140 meters) are not the actual dimensions of the UFO. The radar dimensions represent a volume of air in which the electronic density was sufficient to deviate the 9000 MHz radar waves. However, the presence of free electrons did not limit itself to the region surrounding the UFO, which is approximately 15 % of the distance separating the B-52 and the UFO during the sequence of radar photographs.

It is probable that the electronic density diminished progressively at some distance from the UFO in a way proportional to the square or cube of distance. Since the B-52 was situated about seven times farther away from the UFO than the zone of ionization, it is probable that the electronic density near the B-52 was equal to at least 1/50 or 1/350 of the electronic density of the *cloud of ions* that produced the radar echo. Evidently *there was a considerable density of electrons around the B-52*, probably in the order of at least 10^{15} electrons per cubic meter, (which is the previous value of N_c divided by 350). Consequently, the VHF communications antenna of the B-52 operating at 270 MHz was *immersed in a relatively conducting gas*. This *did not hinder reception of the VHF communications from RAPCON*, because the corresponding electrical field was insufficient to perturb the atmospheric ions at only a few millivolt VHF voltage at the receiving antenna.

However, when the B-52 copilot pressed the button on his microphone, the transmitter onboard the B-52 was sending its entire power to the quarter wave antenna. In this instance, the amplitude of the antenna's local electrical field was increased, which immediately attracted the ions and the electrons encircling the antenna. With a thick layer of ions encircling the transmission antenna, all of the transmitting power was absorbed in the agitation of ions and the heating of air. Therefore, the radiated power was very weak. In other words, the radiating impedance of the antenna was *bypassed by the bath of ions* as if it had been plunged into a conducting fluid driver such as water. Another way to understand this phenomenon is to consider the critical frequency of ionized air by applying $N = N_c / 350$ to equation (49):

$$F_c^2 = 80.7 N = 80.7 \cdot 2.9 \cdot 10^{15} \implies F_c = 484 \text{ MHz} \quad (49 \text{ bis})$$

In this case the critical frequency (484 MHz) is superior to the frequency of communications (270 MHz) and the wave is returned and absorbed rather than being transmitted.

In addition, the transponder transmitted without a problem because it operated above the critical frequency over 1 GHz. It is remarkable that these considerations of plasma physics are completely consistent with many described facts in this case.

5.10. Discussion 2: Photometric Study and the Ionized Cloud Surrounding the UFO

Thanks to the fact that Tom Tulien sent full-sized photographic copies of the original first-generation 8 X 10 prints, we have been able to study the variation of the photo darkening (**Var**) along the right side of the radar ground echo in photo 783. These variations allowed us to confirm the following equation for the radar screen brightness **Sb** of the echoes:

$$\mathbf{Sb} = \mathbf{KVar} = \mathbf{K} \sin^2 (\varphi) \sin^2 (\alpha) / \mathbf{D}^4 \quad (51)$$

For the different ranges **D** indicated in Figure 51 we have the following results:

- For **D = 2.5 nm range**, **Var = 0.2768**.
- For **D = 3 nm range**, **Var = 0.8976**.
- For **D = 4 nm range**, **Var = 3.1395**.
- For **D = 5 nm range**, **Var = 6.5332**.

We can normalize these values for the 2.5 nm range and call them **Var1**, which means that we have increased all the previous values by a factor 3.613:

- For **2.5 nm range**, **Var1 = 1**.
- For **3 nm range**, **Var1 = 3.24**.
- For **4 nm range**, **Var1 = 11.34**.
- For **5 nm range**, **Var1 = 23.60**.

This calculation was simply a change of the value of the constant **K** in equation (51). As previously stated, these results simply show that the **Sb** screen-echo brightness observed for the ground was 23.6 times greater at the 5 nm range than at the 2.5 nm range.

In Figure 51, we measured the incidence angle φ of the radar beam on the ground close to the altitude hole limit at 39 degrees. The ground return was reduced by a factor $\sin^2(\varphi) = 0.396$ in this direction. The scenario is exactly the same for all the photos, because the altitude hole edge remains at 50 degrees from the B-52 nadir, while the altitude hole edge angle φ remains equal to 39 degrees.

Our study has also *confirmed that the photographic emulsion was used in the linear range of its exposure. This means that the emulsion darkening Ed% was proportional to the logarithm of the radar screen brightness Sb:*

$$Ed\% = \gamma \log(Sb) \quad (52)$$

In this equation, the constant γ measures the sensitivity factor of the photographic emulsion, as well as the efficiency of the chemical treatment of the photos. This γ constant should be the same for all 14 photos, because they were processed in the same emulsion.

Transferring equation (51) to equation (52) we have:

$$Ed\% = \gamma \log \{K \sin^2(\varphi) \sin^2(\alpha) / D^4\} \quad (53)$$

This can be written:

$$Ed\% = \gamma \{ \log(K) + 2 \log \{ \sin(\varphi) \} + 2 \log \{ \sin(\alpha) \} - 4 \log(D) \} \quad (54)$$

From the photometry of the ground echo in photo 783 we get:

- **For $D = 2.5 \text{ nm}$ $Ed\% = 5.33 \%$ average darkening, with $\varphi = 29^\circ$ and $\alpha = 10^\circ$**
- **For $D = 5 \text{ nm}$ $Ed\% = 12.33 \%$ average darkening, with $\varphi = 14^\circ$ and $\alpha = 25^\circ$**

Using these values in (52) we calculate:

For 2.5 nm:

$$5.33 = \gamma \{ \log(K) - 3.74122771 \} \quad (55)$$

For 5 nm:

$$12.33 = \gamma \{ \log(K) - 4.7766331 \} \quad (56)$$

By dividing (56) by (55):

- **$\log(K) = 2.9528405$**

Thereby,

- **$K = 897$, and $\gamma = -6.76$**

The ground signal in equation (54) becomes:

$$Ed\% = -19.96 - 13.52 \log \{ \sin(\varphi) \} - 13.52 \log \{ \sin(\alpha) \} + 27.04 \log(D) \quad (57)$$

In this equation, $Ed\%$ is expressed in % and D is expressed in nautical miles. *Equation (57) is a real calibration of the whole chain of systems that were used from the radar pulse transmitter to the final photograph.* If the radar operator adjusts the radar gain or screen brightness, only the constant K is modified, which concerns only the constant factor of the equation (57). By subtracting the values of $Ed\%$ for two echoes of the same photo, this constant

is eliminated and what remains is the calibration of the action of the two angles φ and α plus the one of the distance D . This is an important progress in our analysis.

Let us now return to the photometry we measured for the UFO echoes in the different photos, which was presented previously in Table 4.

| PHOTO | UFO echo % | GROUND echo % | Distance UFO (nm) |
|--------------|-------------------|----------------------|--------------------------|
| 771 | 67 | 91 | 1.73 |
| 772 | 58 | 91 | 1.12 |
| 773 | 81 | 91 | 1.05 |
| 775 | 94 | 89 | 1.69 |
| 776 | 56 | 90 | 1.08 |
| 777 | 47 | 84 | 1.05 |
| 778 | 61 | 78 | 1.05 |
| 779 | 51 | 80 | 1.00 |
| 780 | 66 | 80 | 1.05 |
| 781 | 52 | 90 | 0.95 |
| 782 | 52 | 90 | 0.91 |

Table 7. Summary of photometric measurements of UFO echoes, the ground echoes, and UFO distances.

The first two columns of this table show the values of the previous parameter $E_d\%$, expressed in % for the UFO Echo (**UFO Echo%**) and for the ground echo (**Ground echo%**) close to the altitude hole edge. The last column indicates the UFO echo distance given by the radar in nautical miles.

If we had $\varphi = 90^\circ$, instead of $\varphi = 29^\circ$ for the 2.5 nm distance ground echo in equation (57), we would know the intensity of the echo for a perfectly reflecting surface that is

perpendicular to the microwave beam of the radar. The change in the emulsion darkening for this perfect reflection target would be $13.52 \log(\sin(29^\circ))$ because $\log(\sin(90^\circ)) = 0$. *This is a 4.25% increase in the photo darkening.*

Based on the following two hypotheses:

- **The ground has a radar albedo of 100% for microwaves perpendicular to its surface (which means that it is a quasi-perfect conductor).**
- **The UFO also has a radar albedo of 100%.**

We can compare the real echo of the UFO with the echo of a perfectly reflecting surface situated on the ground by simply adding 4.25% to the value of the ground echo, as follows.

| PHOTO | UFO echo % | GROUND echo % | GROUND echo + 4.25 % | Distance UFO (nm) | Alt hole radius (nm) |
|--------------|-------------------|----------------------|-----------------------------|--------------------------|-----------------------------|
| 771 | 67 | 91 | 95 | 1,73 | 2.20 |
| 772 | 58 | 91 | 95 | 1,12 | 2.13 |
| 773 | 81 | 91 | 95 | 1,05 | 2.13 |
| 775 | 94 | 89 | 93 | 1,69 | 2.04 |
| 776 | 56 | 90 | 94 | 1,08 | 2.04 |
| 777 | 47 | 84 | 88 | 1,05 | 1.98 |
| 778 | 61 | 78 | 82 | 1,05 | 1.97 |
| 779 | 51 | 80 | 84 | 1,00 | 1.95 |
| 780 | 66 | 80 | 84 | 1,05 | 1.90 |
| 781 | 52 | 90 | 94 | 0,95 | 1.87 |
| 782 | 52 | 90 | 94 | 0,91 | 1.83 |

Table 8. Comparison of photometric measurements with the signal from a virtually perfect reflector on the ground. The third column (GROUND echo + 4.25%) shows the corrected value for a 100% reflecting ground.

Now let us consider the following equation derived from equation (57), where $\varphi = 90^\circ$ and $D = 2.20 \text{ nm}$, corresponding to the corrected ground echo of photo

$$95 = - 19.96 - 13.52 \log \{ \sin(\alpha) \} + 27.04 \log (2.20) \} \quad (58)$$

This calculation generates a correct angle Alpha that is close to zero. We have determined from equation (58) that:

$$- 13.52 \log \{ \sin(\alpha) \} = 105.7$$

Therefore, equation (58) becomes:

$$95 = - 19.96 + 105.7 + 27.04 \log (2.20) \} \quad (59)$$

This is $95 = 95$, and therefore true. Let us consider the following equation derived from equation (57), where $\varphi = 90^\circ$ and $D = 1.73 \text{ nm}$ corresponding to the UFO echo of photo 771

$$67 = - 19.96 - 13.52 \log \{ \sin(\alpha) \} + 27.04 \log (1.73) \} \quad (60)$$

Finally, let us subtract (60) from (59):

$$95 - 67 = 95 + 19.96 + 13.52 \log \{ \sin(\alpha) \} - 27.04 \log (1.73) \} \quad (61)$$

Therefore,

$$67 + 19.96 + 27.04 \log (1.73) \} = - 13.52 \log \{ \sin(\alpha) \} \quad (62)$$

This equation should generate the value of the angle α for the UFO in photo 771, although we find $\alpha \approx 0 \text{ degrees}$. This is normal since $E_d\%$ for the UFO is always smaller than the corrected value of $E_d\%$ for the ground, except in photo 775 where equation (62) becomes:

$$94 + 19.96 + 27.04 \log (1.69) \} = - 13.52 \log \{ \sin(\alpha) \} \quad (63)$$

This equation should generate the value of the angle α for the UFO in photo 775, but again we find, $\alpha \approx 0$ degrees for photo 775.

Finally, *all α angles calculated this way are equal to zero*, because there is a need for *a very high attenuation of the returned signal* to explain why the UFO echo is much smaller than the ground echo, particularly when the UFO distance to the B-52 is always smaller than the ground distance. This means that our previous hypothesis concerning the radar albedo of the UFO is false, because *there is considerable absorption of the radar microwaves beam in the direction of the UFO*. We can calculate this absorption by correcting the value of $Ed\%$, so that the UFO would be at the same distance as the ground-altitude hole edge. If we look at equation (54), we see that:

$$Ed\% = \text{Constant} + 4 \gamma \log (D) \quad (64)$$

If D becomes nD , the value of $ED\%$ is reduced by $4 \gamma \log (n)$, with:

$$n = D (\text{ground}) / D (\text{UFO}) \quad (65)$$

In Table 9, the seventh column provides the value of n . Now the distance correction for the UFO is as follows:

$$\Delta Ed\% = -27.04 \log (n) \quad (66)$$

| 1 | 2 | 3 | 4 | 5 | 6 | 7 | 8 | 9 | 10 | 11 |
|-------|-----------|---------------|----------------------|-------------------|----------------------|----------------------|----------------------------|--------------------|--------------------------------|-----------------|
| PHOTO | UFO echo% | GROUND echo % | GROUND echo + 4.25 % | Distance UFO (nm) | Alt hole radius (nm) | n = D(hole) / D(UFO) | ΔEd 27.04 log (n) | UFO% - ΔEd | $\Delta\%$ with ground + 4.25% | dB Atten |
| 771 | 67 | 91 | 95 | 1,73 | 2.20 | 1.2716 | 2.8 | 64.2 | 30.8 | 23 |
| 772 | 58 | 91 | 95 | 1,12 | 2.13 | 1.9018 | 7.6 | 50.4 | 44.6 | 33 |
| 773 | 81 | 91 | 95 | 1,05 | 2.13 | 2.0286 | 8.3 | 72.2 | 22.8 | 17 |
| 775 | 94 | 89 | 93 | 1,69 | 2.04 | 1.2071 | 2.2 | 91.8 | 1.2 | 0.9 |
| 776 | 56 | 90 | 94 | 1,08 | 2.04 | 1.8889 | 7.5 | 48.5 | 45.5 | 34 |
| 777 | 47 | 84 | 88 | 1,05 | 1.98 | 1.8857 | 7.5 | 39.5 | 48.5 | 36 |
| 778 | 61 | 78 | 82 | 1,05 | 1.97 | 1.8762 | 7.4 | 53.6 | 28.4 | 21 |
| 779 | 51 | 80 | 84 | 1,00 | 1.95 | 1.9500 | 7.8 | 43.2 | 40.8 | 30 |
| 780 | 66 | 80 | 84 | 1,05 | 1.90 | 1.8590 | 7.3 | 58.7 | 25.3 | 19 |
| 781 | 52 | 90 | 94 | 0,95 | 1.87 | 1.9684 | 8.0 | 44.0 | 50.0 | 37 |
| 782 | 52 | 90 | 94 | 0,91 | 1.83 | 2.0110 | 8.2 | 43.8 | 50.2 | 37 |

Table 9. Calculation of the attenuation of the UFO returned radar echo by the surrounding ion cloud.

The eighth column provides the value of $\Delta Ed\%$. By subtracting this (negative) value from the value of the UFO echo% in column 2, we receive the corrected **Ed%** for the UFO in column 9. This is the value of the photo darkening we would see if the UFO were situated at the same distance as the altitude hole edge. By subtracting column 9 from column 4, we get column 10, which is the calculated UFO echo attenuation expressed in *photo darkening*. We find a relatively large attenuation because it corresponds to a variation of the photo emulsion darkening in the order of 50% of the ground echo in the photos.

However, we have to remember that the photographic emulsion generates a darkening that is proportional to the logarithm of the screen echo brightness. Determining the value of the attenuation expressed in decibels (**dB Atten**) requires a multiplication of column 10 by **20 / 4y** to get column 11. *The column 11 values are the attenuation in decibels of the radar signal if the UFO albedo is assumed to be 100% in the center of an absorbing cloud.* In fact, the size of

the UFO is so large that if it were made of metal, it should have returned a much brighter echo than the ground echo close to the altitude hole *edge*, *since the UFO is always closer to the B-52 than to the ground*. But this is not what the photos show, except photo 775 where the UFO echo is approximately as bright as the ground echo. *In all other photos, the attenuation of the echo compared to the echo in photo 775 is in the order of 29 decibels on average*, which is a relatively large attenuation.

Because we had not yet calibrated the whole system (radar + photos), we made the assumption that the radar camera was linear, much like a modern CCD camera. However, we see now that this is not the case. Instead, *the B-52 radar camera was logarithmic. Therefore, the UFO echo attenuation can no longer be explained by the UFO movement, which would change the value of the α angle, and give corresponding radar antenna attenuations*. This

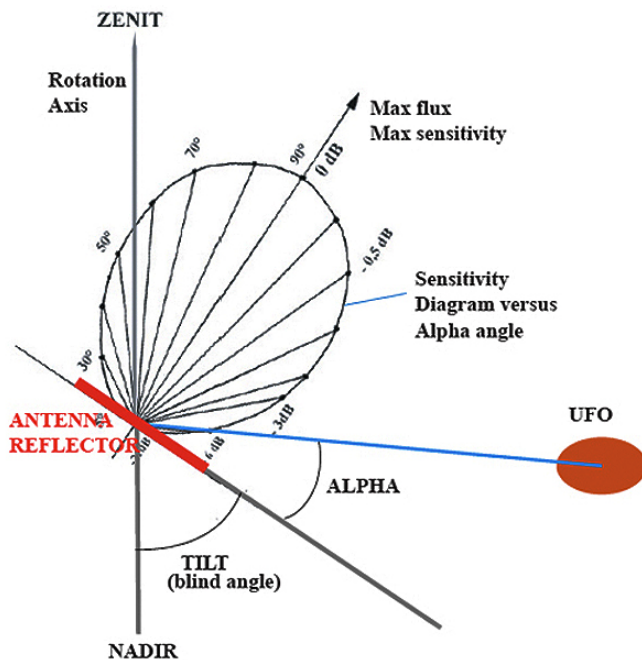

does not necessarily signify that the UFO did not move up and down, but rather, that the resulting attenuation from a change of this angle is quite small compared to the 29 decibels we calculated. This is shown in Figure 49, where the antenna attenuations (a few decibels) are indicated versus angle α .

The large attenuation of the radar echo for the UFO also explains why there was a complete interruption of the radio

transmissions from the B-52 to radar approach control at Minot AFB, because the attenuation of the transmitted signals in the VHF frequency band was much greater than 29 decibels. It is

unlikely that this large attenuation is attributable to a position of the UFO in the blind cone of the radar antenna. If this were the case, the ground echo would not be abruptly cut at a 50-degree angle, as we see in all photos. The ground signal should be about half of that, which is exactly what we see inside the altitude hole up to the point where the radar distance would be equal to the altitude. For example, the ground altitude in photo 783 was $8865 - 1823 = 7042$ feet, which corresponds to 1.16 nm. However, in Figures 52 and 53, we see that the altitude hole radius in photo 783 is abruptly cut close to 2.0 nm, and we have no ground signal at all between 1.16 and 2.0 nm, which corresponds to 42% of the altitude hole radius. It is also unlikely that this large attenuation could be attributed to a particular absorbing skin of the UFO that prevents radar detection in advanced military aircraft. The size of the radar echo would not be much larger than the visual dimensions attested by several witnesses.

The only explanation we find for this attenuation of 29 dB is a thick cloud of ionized air surrounding the UFO. The presence of this cloud is coherent with the visual observation of the luminosity of the UFO, and with the interruption of the VHF transmissions on two occasions when the B-52 was close or closer than about one nautical mile. The oversized radar echo is also coherent in comparison to the various witness descriptions of the UFO size.

In summary, the photogrammetric and photometric study we have undertaken on copies of the original B-52 radarscope photographs has increased the accuracy of the reconstruction of the radar observation. It has allowed us to determine the most probable B-52 descent trajectory, and it has given the most probable value (50°) for the radar antenna tilt-up angle. An accurate mathematical model of the whole system of the radar photos has been derived that provides a confirmation of the presence of a large ionized cloud of gas surrounding the UFO.

Conclusion

It is interesting to consider that this apparently non-aerodynamic aerial device has no comparison with all currently known technological developments. Here again, we are dealing in one or more devices in which the dynamics and energy characteristics are quite simply phenomenal, and have the theoretical potential to allow for an interstellar voyage.

Effectively, the maximum UFO acceleration deduced from the B-52 radarscope photos (400 g's) allows for a relativistic speed (more than 90% of the speed of light) in a relatively short time (less than a day). This is one of the two indispensable conditions for traveling between stars, since it allows sufficient relativistic time “compression” for the crew to arrive at the destination during their life span. The second indispensable condition is the ability to produce a tremendous amount of energy onboard the spacecraft, something the Minot UFO has demonstrated in its powerful light emissions, and phenomenal maneuvers.

In this case, we also have a panoply of interesting physical effects, including the extreme luminosity of the air, loss of the B-52 VHF transmissions on two discrete occasions, and a powerful radar echo. We will probably never know all the facts, but what we have been able to reconstruct is perfectly clear from my point of view, and reinforces what I have written on the site www.universons.com/.

The conclusions of Blue Book in 1968 appear perplexingly ridiculous, however, it really doesn't matter since the truth is inherent. And this truth implicates knowledge of considerable potential for the future of humanity. We need to join efforts to understand the physics revealed, since it is by the union of our knowledge that we will advance our understanding.

Dr. Claude Poher
Toulouse, France
6 August 2005

Appendix 1:

Timing of the B-52 Approach Trajectory and Setting of the Radarscope Clock

The documentation features three time sources, which can be compared to the calculated times of our reconstruction of the trajectory of the B-52. The time entries in the Transcription of Recorded Conversations (Transcript) were encoded relative to the communications according to the RAPCON approach controller's clock at Minot AFB. The B-52 radar operator and the B-52 pilot manually set the time of the onboard clocks during the preflight checklist, including the radarscope clock. To be precise, the radarscope "clock" is actually a watch, manufactured by Bulova, which is wound and set prior to each mission.²³

- **Let us call (COM) the Transcript TIME, which corresponds to GMT.**
- **Let us call (RAD) the TIME indicated by the B-52 radarscope clock, which should also be synchronized to GMT (a hypothesis we want to verify).**
- **Let us call (PIL) the TIME indicated by the pilot chronometer, which should correspond to (RAD).**

According to the Transcript, the B-52 passed over the TACAN WT fix (initial approach fix) and departed FL 200 at 8:54:00 (COM).²⁴ At this time, the B-52 was located 35 nm from the Deering TACAN at azimuth 306° true. According to our calculations, the distance traveled by the B-52 to the position where photo 783 was taken is 16.2 nm and would have required 0:03:53

²³ The navigator would obtain a GMT time "hack" from the National Institute of Standards and Technology (NIST) radio station, WWV, at Fort Collins, Colorado. This time was then transferred to the rest of the crew during pre-flight planning at base ops. The navigator would simply say, "It will be [pick a time] in [x] seconds," and the nav would count down to zero and the rest of the crew would set their watches to that time. The crewmembers would then transfer that time to the onboard chronometers during preflight checklists.

²⁴ Transcription of Recorded Conversations, *Transcript of tape for 24 Oct 68, 0854Z [3:54 a.m. CDT]*. The Transcript is time-coded to GMT (-5 hours CDT). Available from: <http://www.minotb52ufo.com/pdf/0017.pdf>.

minutes at a speed of 250 kts. Although it is unlikely that the speed of the aircraft remained constant during this period, this time would not vary considerably. We can deduce that the (COM) time at photo 783 is: $8:54:00 \text{ (COM)} + 0:03:53 = 8:57:53$.

In order to determine the elapsed time to the position of the B-52 at photo 783, we have shown that the distance (Dis783) the B-52 traveled away from the WT fix along the trajectory would be equal to 13.7 nm. At a speed of 250 kts, this would have required 03:17 minutes. It is unlikely that the speed of the aircraft remained constant during this period, but the time would not vary too considerably. Therefore, we can deduce that the exact time of photo 783 would be: $8:54:00 + 0:03:17 = 8:57:17 \text{ (COM)}$.

Following is the resolved position of the B-52 along the descent trajectory, at the precise time indicated by the clock in the last radarscope (photo783):

- **Indication of the radarscope clock in photo 783 = 9:06:51 (RAD).**
- **Ground altitude of the B-52 during photo 783 = 6205 feet (35).**
- **MSL altitude of the B-52 during photo 783 = 7928 feet.**
- **Deering TACAN position of the B-52 at photo 783 = 18.8 nm / 306° true.**

If we compare this to the precise time of the radarscope clock in photo 783, we find a significant discrepancy. This difference is equal to $9:06:51 \text{ (RAD)} - 8:57:53 = 00:08:58$, or 9 minutes. This discrepancy has been established from information in the documents, which suggest that the radarscope clock (RAD) was not set to the same time as the approach controller's clock (COM); the pilot's chronometer (PIL) should show a similar discrepancy.

There are additional indications in the documents that are consistent with our reconstruction of the B-52 trajectory. At about 08:58 (COM), the radio transmission from the B-

52 is interrupted in mid-sentence, which is equivalent to the calculated (COM) time of photo 783 at 8:57:53.²⁵ Thus, it is apparent that the B-52 loss of radio transmission and the sequence of radar photographs occurred concomitantly.

These speculations are confirmed further when we consider that the approach controller contacts the tower controller, while the communications with the B-52 are interrupted, effectively locating the B-52 along its trajectory at a specific time: “09:00 ct to tw: Tower this is on JAG 31, disregard, he is about 24 miles out. . . .”²⁶ According to our calculations, at the beginning of the loss of communications (probably photo 771), the aircraft was exactly 21.37 nm (or 24.6 statute miles) from the Deering TACAN.

According to the Transcript, at 09:01 (COM), communications were very weak on 271.3 Mhz, and at 09:02 the communications are restored.²⁷ If we ignore the range of the effect of the B-52 radio transmission loss as a result of the close proximity of the UFO, we note that it is precisely during the beginning of the series of radarscope photos that radio communications failed. VHF communications were restored one or two minutes after the UFO departed from the radarscope.

Let us examine now the trajectory of the B-52 following photo 783, taken at 8:57:53. At the calculated (COM) time of photo 783 the B-52 is 18.8 nm from the Deering TACAN. The B-52 continues the descent, executes a “missed approach” to the runway, and at 9:06 (COM) announces “31 going around,” which means that the B-52 left the axis of the runway at 110

²⁵ Transcript, 0858+. Available from: <http://www.minotb52ufo.com/pdf/0017.pdf>.

²⁶ Transcript, 0900-0902.

²⁷ Transcript, 0900-0902.

degrees and turned left onto the traffic pattern to execute the GCA low approach requested at the beginning of the descent.²⁸

According to the approach plates, from time 8:57:53 on photo 783 until 09:06 (COM) the B-52 traveled $18.8 + 2.9 = 21.7$ nm, which would require 7 minutes, if photo 783 were taken at 08:58. This corresponds to an average speed of 186 kts, a speed that was confirmed by Col. Werlich in the documents and which is correct for the final approach and traffic pattern speed.²⁹ The position of the B-52 at 09:06 (COM) is consistent with the speed and distance traveled by the B-52 from its location at photo 783, and further confirms the position of the B-52 at the instant of photo 783. This position is also consistent with our reconstruction of the trajectory of the B-52, and the time entries in the Transcript of Recorded Conversations.

At 09:09 (COM), the copilot of the B-52 pilot reports: "Steady 335 3200," indicating that he is stabilized in horizontal flight on the magnetic heading 335 degrees at an altitude of 3200 feet MSL (1500 feet above the ground).³⁰ This was the standard procedure to follow in 1968 at Minot AFB. The course leads the B-52 to move away from the runway, after a left turn of $335 - 110 = 225^\circ$.

Towards 09:10 (COM), the tower orders the B-52 to take the new magnetic course 290 degrees and to maintain altitude at 3200 feet MSL.³¹ The B-52 is now turning onto the "downwind" leg in the traffic pattern, parallel to the runway.

²⁸ Transcript, 0906.

²⁹ "ELECTRONIC SIGHTING DATA: . . . 280-230 IAS; . . . VISUAL SIGHTING DATA: . . . 180 IAS." Basic Reporting Data, 2. Available from: http://www.minotb52ufo.com/pdf/Basic_Reporting_Data.pdf.

³⁰ Transcript, 0909.

³¹ Transcript, 0909+.

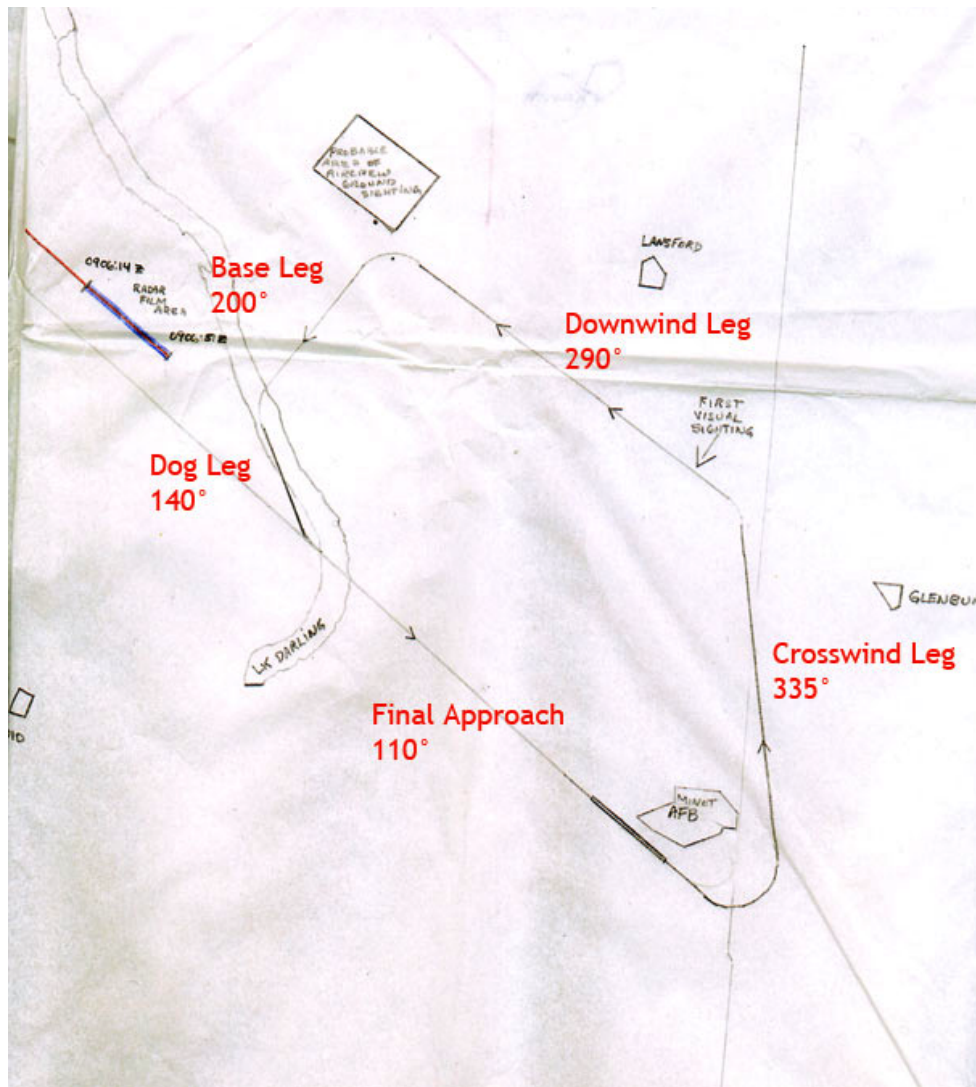

Figure 69. Standard traffic pattern executed during the first go-around, prior to the air-visual observation of the UFO during the second go-around.

Around 09:14 (COM), the controller orders magnetic course 200 degrees, altitude 3200 feet MSL.³² This vectors the B-52 to the “base leg” of the circuit, which is perpendicular to the axis of the runway.

At 09:15 (COM), the tower orders magnetic course 140 degrees, altitude 3200 feet MSL. The B-52 has therefore turned left by $200 - 140 = 60$ degrees. This is referred to as an approach with final *dogleg*, which brings the aircraft to 30 degrees from the axis of the runway in order to

³² Transcript, 0913+. Available from: <http://www.minotb52ufo.com/pdf/0017.pdf>.

safely avoid excessive course changes at low speed. The B-52 is then vectored to the final approach at 110 degrees, which centers the B-52 on the axis of the runway. At 9:17 the B-52 reaches the Final Approach Fix at a distance of 6.3 nm from the Deering TACAN to begin its final descent to the runway.³³

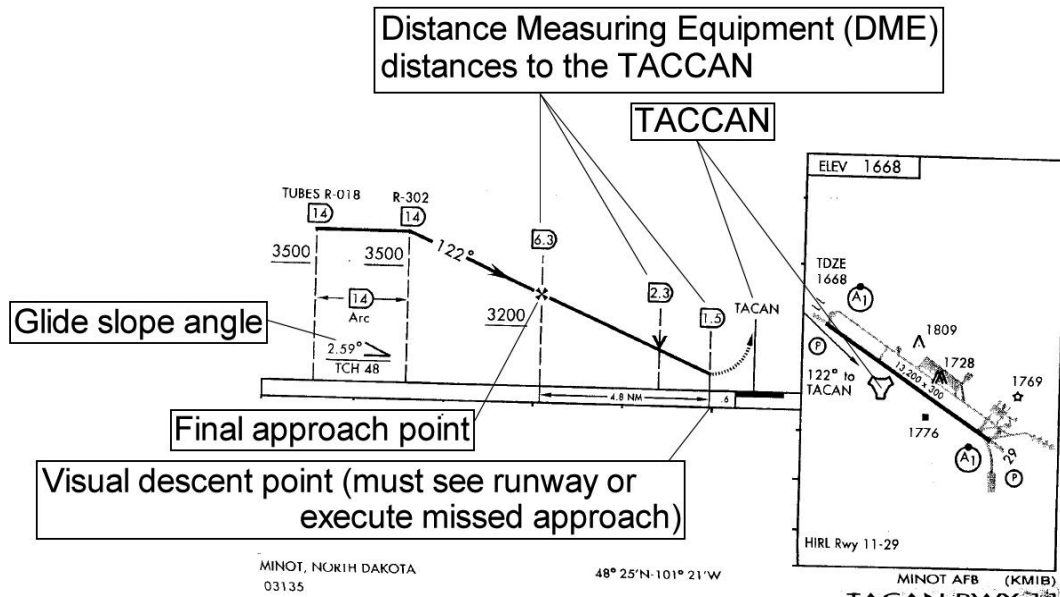

Figure 70. Detail of approach and runway from the Minot AFB Instrument Approach Procedures (approach plates).

Let us sum up the displacements of the B-52 since FL 200 from the WT fix where it began its descent at 08:54 (COM) until 09:17 (COM).

- **Initial descent from 35 to 21.37 nm from the Deering TACAN.**
- **The series of 14 radar photographs locating the B-52 at 18.8 nm.**
- **An uninterrupted descent to the Final Approach.**
- **A missed approach to the runway is accomplished.**

³³ For a detailed explanation of Instrument Approach Procedures see: http://www.flightsimaviation.com/aviation_theory_15_Instrument_Approach_Procedures_part_1.html. The current 2011 Minot AFB (KMIB) airport diagram, and IAPs, or “approach plates,” are accessible online (IAPs near the bottom of the page) at: <http://www.airnav.com/airport/KMIB>.

- **At 09:06 (COM) the B-52 initiates the standard traffic pattern, which will bring it in Final Approach at 09:17 (COM), which is 5.4 nm from the threshold of the runway, or 6.3 nm from the Deering TACAN.**

This is consistent with standard procedures and corresponds to the speed of a B-52 on approach to landing at Minot AFB. The (COM) time references are fairly coherent with the B-52 trajectory throughout the first circuit around the traffic pattern. Events during the second and final circuit become more interesting.

Timing of the B-52 Trajectory Until Terminal Landing

It takes 11 minutes for the B-52 to go around at 09:06 (COM) and to arrive at the position of the Final Approach Fix (FAF) beacon at 09:17 (COM). Additional time is required for the final approach and landing. On the approach plates, the length of the final approach and landing segment is 7.6 nm, which means that the B-52 took an additional 2 or 3 minutes at its approach speed to land. The total is $11 + 2 \text{ to } 3 = 13 \text{ to } 14$ minutes. Therefore, we know the flight times of the various legs of the standard traffic pattern. Let us begin at the time when the B-52 was at the FAF for the first time.

(ac = B-52 [JAG 31]; ct = controller). All times are from (COM) clock

- **09:04+ ct Cleared for low approach . . .**
- **09:06 ac 31 going around**
- **09:09 ac Steady 335 3200 (crosswind leg)**
- **09:10? ct JAG31 turn left heading 290, maintain 3200 downwind leg**
- **09:13+ ct JAG31 turn left heading 200, maintain 3200 base leg**
- **09:15 ct JAG31 turn left heading 140, maintain 3200 dogleg to final**
- **09:16 ct JAG31 turn left heading 110, maintain 3200**

- **09:17 ac Final approach.**

Consequently, the approximate time durations are:

- **Crosswind leg heading 335° = 1 minute**
- **Downwind leg heading 290° = 3 minutes**
- **Base leg heading 200° = 1 minute**
- **Dogleg heading 140° = 2 minute**
- **Final Approach heading 110° before Final Approach Fix = 1 minute**
- **FAF to terminal landing = about 3 minutes.**

Therefore, the total time is 13 minutes after the previous passage of the FAF, and 11 minutes after overtaking of the runway. However, at 09:21(COM), 4 minutes after the FAF the B-52 calls the controller requesting: “I’d like to get a vector around for an IFR, surveillance approach.”³⁴ The pilot asks for vectors to be followed for an *Instrument Flight Rules* (IFR) surveillance approach, which means that the B-52 can go down to minimums, while the heading corrections are issued by the ground controller.

The B-52 pilot also adds that he wants to terminally land at 09:40 (PIL). If we add 11 minutes to 09:21 (COM), we get 09:32 (COM), which leaves a margin of eight minutes for enlarging the traffic pattern in order to fly over the UFO, if we subtract 09:32 (COM) from 09:40 (PIL?) (assuming that these two clocks are synchronous), this eight minute difference therefore seems consistent.

In the Transcript there are no specific time indications between 09:21 (COM) and 09:28 (COM), specifying the *final landing* of the B-52. Indeed, the B-52 could not have been on final

³⁴ Transcript, 0921. Surveillance approach (ASR, SRA) is an instrument approach conducted in accordance with directions issued by ground controllers referring to the surveillance radar display. Since guidance is only provided in azimuth, it is a non-precision approach. Controller guidance terminates at between 2 nm and 0.5 nm from touchdown, at which point the pilot must either be visual with the runway, or must go around.

approach at 09:28 (COM) because the successive headings were exactly the same as the ones during the previous traffic pattern, which assumes the same geometry for the final pattern. We know that the normal traffic pattern could not be completed in less than 11 minutes; therefore, the B-52 could not be on final approach at 09:28 (COM). At the very least, this suggests that the final times of the transcription of radio communications are distorted.

```
0917      Final approach
0921 ac   Approach control this is 31
        ct   JAG 31 this is Minot approach control go ahead
        ac   I'd like to get a vector around for an IFR, surveillance approach, like to
        ct   touch down at 40 past
        ac   Roger you want a full stop at 40
        ct   Affirm be termination
        ct   JAG 31 roger turn left heading 335 maintain 3200 this will be a vector to
        ac   the surveillance final approach course rw 11 usable length 13,200, descent
        ct   to minimum descent altitude will be authorized 5 miles from rw
        ac   31 roger
        ct   Lost communications remain the same do you wish any portion repeated
        ac   Negative 31
        ct   31 roger
        ct   (garbled)
        ac   31 roger
        ct   JAG 31 (garbled) requests that somebody from your aircraft stop in at

Page 3

        basops after you land
        ac   Roger 31 we'll give them a call
        ct   31 roger
        ct   JAG 31 turn left heading 200 maintain 3200 base leg
        ac   Roger 200 3200
        ct   JAG 31 turn left heading 140 maintain 3200
        ac   140 3200 JAG 31
        ct   JAG 31 turn left heading 115 maintain 3200 extended final
        ac   Roger 31 understand heading 115?
        ct   31 roger heading 115
0928      JAG 31 on final for landing
```

Figure 71. Transcription of Conversations between the B-52 and RAPCON, from 09:17 (COM) to the end of the document. These are conversations during the second circuit of the traffic pattern prior to terminal landing. The time references after 4:21 have been omitted, including the vector for the 290° downwind leg of the traffic pattern when the pilots observed the UFO.

The pilot stated, “Like to touch down at [09:]40 past,” and the controller responded “Roger you want a full stop at [09:]40,” which are dissimilar requests since touch down refers to

the wheels on the runway, while full stop is terminal with engines shut down. If we examine the satellite image of Minot AFB, we see that the end of the runway is less than a mile from the B-52 parking area. Conceivably, 2 or 3 minutes separate the two procedures. The successive traffic pattern circuits appear to be the same, with the exception of a couple points:

- **Pilot's request for an IFR, surveillance approach**
- **The downwind leg is completely omitted (290° at 3200 feet)**
- **The pre-final dogleg branch is a course heading of 115° rather than 110°.**

Additionally, the controller validates the pilot's request, "This will be a vector to the surveillance final approach," adding, "Lost communications remain the same. Do you wish any portion repeated?"³⁵ The controller seems to be taking precautionary measures in order to avoid another loss of radio communications. Although B-52 crewmembers recalled the order to overfly the UFO, this specific request is not included in the transcript. It seems to be implied by the request, "JAG 31 (garbled) requests that somebody from your aircraft stop in at baseops after you land."³⁶

The Transcript contains various lacunae, yet the accurate time references are missing for at least 7 minutes. I therefore undertook a reconstruction of the trajectory of the B-52 during this *special* pattern by going backwards and forward from the times we know precisely. An important indicator in the Transcript is evident in the fact that the arrival at the Final Approach Fix is not made according to the heading of the axis of the runway, but on a course of 115 degrees, thereby shortening the distance to the runway.

³⁵ Transcript, 0921+.

³⁶ Transcript, 0921+.

We know that professional military pilots work with great accuracy, particularly near a base that has numerous heavy bomber movements. Because of their large, long-range design, these bombers are especially difficult to navigate when approaching the runway at night and during instrument approaches. Therefore, it seems to me that the controller intended to satisfy the request of the pilot by stating, “Roger you want a full stop at 40” (COM). The B-52 had to be at the FAF (at the beginning of final approach) at 09:34 (COM), in order that the touchdown occurs at $09:38 \pm 1$ minute (COM).

We know that the B-52 exceeded the end of the runway at 09:21 (COM), and the complete time duration of this special circuit had to be equal to $09:34 - 09:21 = 13$ minutes. This is two minutes more time than the previous normal pattern (11 minutes). In fact, it is enough to slightly lengthen the downwind leg by 1 minute to get this result (1 minute going out + 1 minute for return = the two minutes of difference from the previous pattern). On the basis of the indicated headings, we can now put this unknown traffic pattern into equations. Following, I shall reconstruct a pattern from the indicated courses in which the complete duration is 13 minutes at the speed of 180 kts. Let us call:

- **L1 the length of the leg on the course 335° (Crosswind leg)**
- **L2 the length of the leg on the course 290° (Downwind leg)**
- **L3 the length of the leg on the course 200° (Base leg)**
- **L4 the length of the leg on the course 140° (Dogleg)**
- **L5 the length of the leg on the course 115° (Final Approach).**

There are five turns (made with the standard rate of 180° per minute), the durations of which we will call:

- **T1 = duration of the first turn, begun at 09:21 (COM) from the runway heading (110°) to course 335°, which is the beginning of L1. This is a turn of 225° that lasts 1 minute and 15 seconds.**
- **T2 = duration of the second turn from course 335° to course 290°, which is the beginning of L2. It is a turn of 45° that lasts 15 seconds.**
- **T3 = duration of the third turn from course 290° to course 200°, which is the beginning of L3. It is a turn of 90° that lasts 30 seconds.**
- **T4 = duration of the fourth turn from course 200° to course 140°, which is the beginning of L4. It is a turn of 60° that lasts 20 seconds.**
- **T5 = duration of the fifth turn from course 140° to course 115°, which is the beginning of L5. This is a turn of 25° that lasts 8 seconds.**

Total time of turns = 148 seconds (2 minutes and 28 seconds). It took 10 minutes and 32 seconds to go through the straight leg, which corresponds to 31.6 nm at a speed of 180 kts. Therefore,

- **The sum of the length $L1 + L2 + L3 + L4 + L5 = 31.6$ nm.**

In addition, the geometry of the complete trajectory imposes a closed circuit, establishing narrow relations between the lengths of the various branches. We know that the distance between the end of L5 (the end of the runway) and the beginning of turn T1 is 3.6 nm. As a result, according to the trigonometry of the pattern:

- **$0.7 L1 + L2 = 0.866 L4 + L5 + 3.6$**
- **$L3 + 0.5 L4 = 0.7 L1$**
- **$L1 + L2 + L3 + L4 + L5 = 31.6$ nm**

We have only three equations with five unknown variables, and therefore several possible solutions. According to the accounts provided by both pilots, the B-52 overflew the UFO during the 90-degree left turn from the downwind leg to the base leg. *Consequently, there must be a non-null base leg (L3).* We could extend progressively the length of the pattern by augmenting

the length of L2 by only 1 nm per step or less. This task should be done on the airport map to verify that the pattern is correctly closed. However, on the map provided by Col Werlich to Blue Book, there is a rectangle drawn near N-7, in the middle of which is written: "Probable area of aircrew ground sighting." We may want to determine if the previous relations between distances L1 to L5, with the times indicated in the Transcript, are compatible with a position of the UFO on or near the ground in the middle of the rectangle. The answer is yes, placing the center of the turn in the middle of the rectangle!

This circuit is:

- **Compatible with the indicated hours in the Transcript (COM).**
- **Compatible with the full stop of the B-52 at 9:40 (COM).**
- **Compatible with the traffic pattern procedure (successive courses) such as it appears twice in the Transcript.**
- **Compatible with the position of the radar photographs.**

The dimensions of this pattern are:

- **L1 = 9.31 nm**
- **L2 = 11.17 nm**
- **L3 = 2.23 nm**
- **L4 = 12.29 nm**
- **L5 = 3.08 nm to the runway threshold; 5.21 nm to the runway end.**

The position of the UFO in the center of the rectangle is located 16 nm from the Deering TACAN, on the true azimuth 334° (321° magnetic). This rectangle appears on a map overlay prepared by Col Werlich in 1968, which also includes the trajectory of the B-52 during its descent from the TACAN WT fix to the runway.

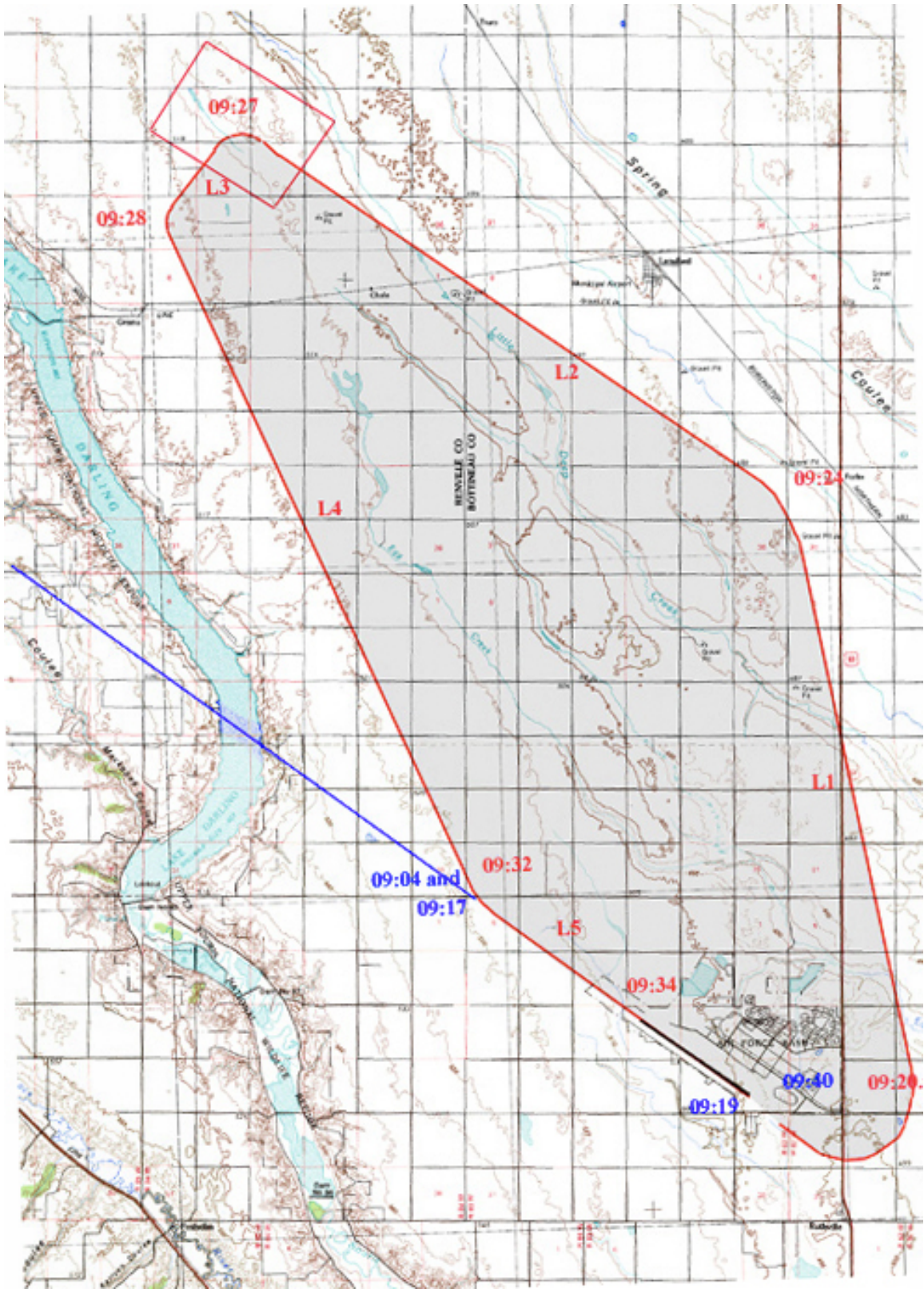

Figure 72. The last traffic pattern of the B-52 in the course of which the crew visually observed the UFO during the turn from the downwind leg (L2) onto the base leg (L3).

Supplementing the Chronological Facts

On the basis of our previous considerations regarding the B-52 trajectory, we can reconstruct the final chronology during which no specific times are indicated in the transcript with the (COM) times:

- **08:58 — B-52 radar photo 783 (B-52 speed = 250 kts. then is reduced to 180 and 150 kts during approach). B-52 radar clock = 09:06:51.**
- **09:04 — Outer Marker and beginning of L5.**
- **09:17 — End of first pattern at the outer marker. “Final approach” announced.**
- **09:19 — End of runway overflown.**
- **09:21 — Beginning of L1.**
- **09:24 — Beginning of L2. (09:33 on pilot clock). The pilots observe the UFO ahead of the B-52 at 11.2 nm.**
- **09:26 — Beginning of turn towards base leg around the UFO (09:35 on pilot clock). Loss of VHF communications.**
- **09:27 — Beginning of L3 (base leg)**
- **09:28 — Beginning of L4. VHF communications restored.**
- **09:32 — Beginning of L5 (final approach).**
- **09:35 — Touchdown of the B-52. (09:44 on pilot clock).**
- **09:40 — B-52 full-stop and parked.**

Major Partin, the pilot of the B-52, reported that he overflew the UFO at 9:35 (PIL), after having viewed the object for five minutes during the course of the downwind leg. He added that the time indications were “fairly certain” since they were acquired “by clock,” which would

imply the onboard pilot chronometer (PIL).³⁸ *The duration of the 11.17 nm flight along L2 at 180 kts corresponds exactly to 3.72 minutes. If we add the duration of the turns, the pilot should have seen the UFO for approximately five minutes.* However, if we examine the difference of time: 09:35 (PIL) to 09:26 (COM), we receive a time difference of 9 minutes, which is **the same and also ahead in time** when compared to our reconstruction of the missing times in the Transcript. It is also obvious that the crew coordinated their chronometers to the GMT hour during the preflight planning. In these conditions, it would be normal to find this difference of the time (PIL) of the UFO overflight indicated by the Major Partin. The hour onboard the B-52, including the radar clock (RAD) and the pilot chronometer (PIL), were both definitely early (by 9 minutes) as compared to the hour of the Transcript (COM), which was in principle recorded with the radio communications.

³⁸ Partin, AF-117, 1, 3. Available from: <http://www.minotb52ufo.com/pdf/0024.pdf>.

Appendix 2

Descriptive Measurements of Radarscope Photos 771 to 784

Note: The distance should not be calculated from the center of the photo, since there is an “offset” of calibration in distance and the first zone is not linear. Distances should be measured by using the circle (range ring) that is visible in all photos at 1.75 nm.

Analysis of Photo 771

Heading of the B-52 = 122°

Heading at the top of the photo = 118.2°

Distance to the edge of the altitude hole = 2.2 nm

I determined the presence of two echoes on this photo on the right side of the aircraft and forward at positions 13 h and 14 h. The smallest seems to be an artifact of the ground.

Small echo: Distance = 2.15 nm Direction = 152°

Large echo: Distance = 1.73 nm Direction = 138°

Orientation of the longer axis of the largest echo = 110 / 290°

Positions on photo:

- Small echo: x = 1071 y = 906 (pixels)
- Large echo: x = 988 y = 935 (pixels)

Position of the B-52: x = 921 y = 1130 (pixels)

Photometric levels:

- Small echo: 70 %; level of neighborhood = 30 %
- Large echo: 67 %; level of neighborhood = 25 %
- Echo of ground near the edge of the altitude hole = 91 %
- NB: Black = 100 % — White = 0 %

Dimension of echoes:

- Large echo: length = 11 pixels; width = 3 pixels (132 x 40 meters).
- Small echo: circle, 2 pixels diameter (28m)

Scale of the photo = 140 pixels per nautical mile (linear, center displaced by 0.25 nm)

The resolution of the radar seems to be 2 pixels.

Analysis of Photo 772

Heading of the B-52 = 124°

Heading of the top of the photo = 117.2°

Distance to the edge of the altitude hole = 2.13 nm

I determined the presence of only one echo on this photo, which is about the same size as the largest one in the previous photo. The echo has moved towards the right rear of the aircraft to a position at 16 h.

Distance = 1.12 nm Direction = 244°

Orientation of the larger axis of the echo = 100 / 280°

Position on photo: x = 970 y = 1194 (pixels)

Position of the B-52: x = 878 y = 1131 (pixels)

Photometric levels:

- Echo: 58 %; level of neighborhood = 19 %
- Echo of ground near the edge of the altitude hole = 91 %
- NB: Black = 100 % — White = 0 %

Dimension of echo: length = 9.4 pixels; width = 4 pixels (120 x 50 meters).

Scale of the photo = 146 pixels per nautical mile (linear, center displaced by 0.25 nm).

Analysis of Photo 773

Heading of the B-52 = 122°.

Heading of the top of the photo = 117.5°

Distance to the edge of the altitude hole = 2.13 nm

I determined the presence of only one echo, which is considerably larger in size than the one in the previous photo. The echo has moved towards the left of the aircraft at a position of 21 h.

Distance = 1.05 nm Direction = 039°

Orientation of the larger axis of the echo = 050 / 230°

Position on photo: x = 783 y = 1061 (pixels)

Position of the B-52: x = 891 y = 1084 (pixels)

Photometric levels:

- Echo: 81 %; level of neighborhood = 23 %
- Echo of ground near the edge of the altitude hole = 91 %
- NB: Black = 100 % — White = 0 %

Dimension of echo: length = 21.2 pixels; width = 9.2 pixels (260 x 113 meters + 185 m with a sort of appendage).

Scale of the photo = 150 pixels per nautical mile (linear, center displaced by 0.25 nm).

Analysis of Photo 774

Heading of the B-52 = unknown

Heading of the top of the photo = 117.7°

Distance to the edge of the altitude hole = 2.06 nm

No apparent echo on this photo. There is a sort of artifact at 0.73 nm / 025°, however this artifact exists on all photos. Its contrast is quite low: 44% neighborhood = 31 %

Positions of artifact on photo: x = 938 y = 1143 (pixels)

Position of the B-52: x = 1003 y = 1140 (pixels)

Scale of the photo = 148 pixels per nautical mile (linear, center displaced by 0.25 nm).

Photometric levels:

- Echo: 41 %; level of neighborhood = 31 %
- Echo of ground near the edge of the altitude hole = 88 %
- NB: Black = 100 % — White = 0 %

The dimension of artifact is too noisy for a correct measurement.

Analysis of Photo 775

Heading of the B-52 = unknown

Heading of the top of the photo = 117.7°

Distance to the edge of the altitude hole = 2.04 nm

I determined the presence of only one echo on this photo with a size comparable to the one in photo 773. The echo has moved towards the rear of the aircraft to a position at 19.5 h.

Distance = 1.69 nm Direction = 348°

Orientation of the larger axis of the echo = 106 / 286°

Position on photo: x = 842 y = 1200 (pixels)

Position of the B-52: x = 1005 y = 1069 (pixels)

Photometric levels:

- Echo: 94 %; level of neighborhood = 65 %
- Echo of ground near the edge of the altitude hole = 89 %
- NB: Black = 100 % — White = 0 %

Dimension of echo: length = 19.2 pixels; width = 7 pixels (247 x 90 meters).

Scale of the photo = 144 pixels per nautical mile (linear, center displaced by 0.25 nm).

Analysis of Photo 776

Heading of the B-52 = unknown

Heading of the top of the photo = 117.9°

Distance to the edge of the altitude hole = 2.04 nm

I determined the presence of three echoes on this photo. One of these echoes has a size comparable to the one in photo 773. This echo has moved towards the front of the aircraft to a position at 21 h.

Echo 1: Distance = 1.08 nm Direction = 040°

Echo 2: Distance = 1.55 nm Direction = 245°

Echo 3: Distance = 1.55 nm Direction = 253°

Orientation of the larger axis of the echo 1 = 040 / 220°

Orientation of the larger axis of the echo 2 = 122 / 302°

Orientation of the larger axis of the echo 3 = 124 / 304°

Positions on photo:

- Echo 1: x = 894 y = 1144 (pixels)
- Echo 2: x = 1148 y = 1266 (pixels)
- Echo 3: x = 1133 y = 1288 (pixels)

Position of the B-52: x = 1006 y = 1166 (pixels)

Photometric levels:

- Echo 1: 56 %; level of neighborhood = 30 %
- Echo 2: 66 %; level of neighborhood = 33 %
- Echo 3: 61 %; level of neighborhood = 36 %
- Echo of ground near the edge of the altitude hole = 90 %
- NB: Black = 100 % — White = 0 %

Dimension of the echoes:

- Echo 1: length = 26,6 pixels; width = 6 pixels (337 x 76 meters).
- Echo 2: length = 18 pixels; width = 5 pixels (102 x 63 meters).
- Echo 3: not measurable (noise).

Scale of the photo = 146 pixels per nautical mile (linear, center displaced by 0.25 nm).

Analysis of Photo 777

Heading of the B-52 = unknown.

Heading of the top of the photo = 117.3°

Distance to the edge of the altitude hole = 1.98 nm

I determined the presence of three echoes on this photo. The upper echo could be an artifact.

Echo 1: middle

Echo 2: lower

Echo 3: upper (artifact?)

Echo 1: Distance = 1,05 nm Direction = 040°

Echo 2: Distance = 1,75 nm Direction = 246°

Echo 3: Distance = 1,58 nm Direction = 094°

Orientation of the larger axis of the echo 1 = 065 / 245°

Orientation of the larger axis of the echo 2 = 060 / 240°

Echo 3 is circular

Positions on photo:

- Echo 1: x = 912 y = 1041 (pixels)
- Echo 2: x = 1179 y = 1181 (pixels)
- Echo 3: x = 942 y = 891 (pixels)

Position of the B-52: x = 1018 y = 1062 (pixels)

Photometric levels:

- Echo 1: 47 %; level of neighborhood = 25 %
- Echo 2: 73 %; level of neighborhood = 46 %
- Echo 3: 79 %; level of neighborhood = 3 % (white dot behind)
- Echo of ground near the edge of the altitude hole = 84 %
- NB: Black = 100 % — White = 0 %

Dimension of the echoes:

- Echo 1: length = 10 pixels; width = 3 pixels (120 x 36 meters).
- Echo 2: length = 17.8 pixels; width = 7.2 pixels (214 x 87 meters).
- Echo 3: diameter 4 pixels (48 meters).

Scale of the photo = 154 pixels per nautical mile (linear, center displaced by 0.25 nm).

Analysis of Photo 778

Heading of the B-52 = unknown

Heading of the top of the photo = 117.7°

Distance to the edge of the altitude hole = 1.97 nm

I determined the presence of only one echo on this photo. The preceding middle echo has not moved at the position of 21 h.

Distance = 1.05 nm Direction = 040°

Orientation of the larger axis of the echo = 082 / 262°

Position on photo: x = 891 y = 1053 (pixels)

Position of the B-52: x = 8975 y = 1076 (pixels)

Photometric levels:

- Echo: 61 %; level of neighborhood = 20 %
- Echo of ground near the edge of the altitude hole = 78 %
- NB: Black = 100 % — White = 0 %

Dimension of echo: length = 8 pixels; width = 5 pixels (100 x 63 meters).
Scale of the photo = 148 pixels per nautical mile (linear, center displaced by 0.25 nm).

Analysis of Photo 779

Heading of the B-52 = unknown.

Heading of the top of the photo = 117.0°

Distance to the edge of the altitude hole = 1.95 nm

I determined the presence of only one echo in this photo. There is also a sort of long filament with a low contrast, at 1.25 nm distance. The preceding echo has not moved from the previous position at 21 h.

Distance = 1.0 nm Direction = 040°

Orientation of the larger axis of the echo = 040 / 220°

Position on photo: x = 914 y = 998 (pixels)

Extremity of the filament: x = 894 y = 994 (pixels)

Position of the B-52: x = 1009 y = 1020 (pixels)

Photometric levels:

- Echo: 51 %; level of neighborhood = 22 %
- Echo of ground near the edge of the altitude hole = 80 %
- NB: Black = 100 % — White = 0 %

Dimension of echo: length = 7 pixels; width = 6 pixels (86 x 74 meters). Length of the filament = 25 pixels (300 meters).

Scale of the photo = 150 pixels per nautical mile (linear, center displaced by 0.25 nm).

Analysis of Photo 780

Heading of the B-52 = unknown.

Heading of the top of the photo = 116.4°

Distance to the edge of the altitude hole = 1.90 nm

I determined only one echo on this photo at the same position as previous at 21 h.

Distance = 1.05 nm Direction = 040°

Orientation of the larger axis of the echo = 065 / 245°

Position on photo: x = 918 y = 1169 (pixels)

Position of the B-52: x = 1018 y = 1192 (pixels)

Photometric levels:

- Echo: 66 %; level of neighborhood = 20 %
- Echo of ground near the edge of the altitude hole = 80 %
- NB: Black = 100 % — White = 0 %

Dimension of echo: length = 12 pixels; width = 4 pixels (150 x 50 meters).

Scale of the photo = 144 pixels per nautical mile (linear, center displaced by 0.25 nm).

Analysis of Photo 781

Heading of the B-52 = unknown.

Heading of the top of the photo = 118.5°

Distance to the edge of the altitude hole = 1.87 nm

I determined the presence of only one echo on this photo. The echo has not moved from the position at 21 h.

Distance = 0.95 nm Direction = 040°

Orientation of the larger axis of the echo = 102 / 282°

Positions on photo: x = 842 y = 1150 (pixels)

Position of the B-52: x = 934 y = 1168 (pixels)

Photometric levels:

- Echo: 52 %; level of neighborhood = 21 %
- Echo of ground near the edge of the altitude hole = 90 %
- NB: Black = 100 % — White = 0 %

Dimension of echo: length = 8 pixels; width = 3 pixels (95 x 35 meters).

Scale of the photo = 156 pixels per nautical mile (linear, center displaced by 0.25 nm).

Analysis of Photo 782

Heading of the B-52 = unknown.

Heading of the top of the photo = 118.7°

Distance to the edge of the altitude hole = 1.83 nm

I determined the presence of only one echo on this photo. The echo has moved slightly at the position at 21 h.

Distance = 0.91 nm Direction = 038°

Orientation of the larger axis of the echo = round, fuzzy

Position on photo: x = 912 y = 1123 (pixels)

Position of the B-52: x = 986 y = 1136 (pixels)

Photometric levels:

- Echo: 52 %; level of neighborhood = 20 %
- Echo of ground near the edge of the altitude hole = 90 %
- NB: Black = 100 % — White = 0 %

Dimension of echo: length = 4 pixels; width = 3 pixels, fuzzy (48 x 36 meters).

Scale of the photo = 154 pixels per nautical mile (linear, center displaced by 0.25 nm).

Analysis of Photo 783

Heading of the B-52 = unknown.

Heading of the top of the photo = 118.7°

Distance to the edge of the altitude hole = 1.82 nm

No echo on this photo.

Position of the B-52: x = 1001 y = 1210 (pixels)

Photometric levels:

- Echo of ground near the edge of the altitude hole = 76 %
- NB: Black = 100 % — White = 0 %

Scale of the photo = 150 pixels per nautical mile (linear, center displaced by 0.25 nm).

Analysis of Photo 784

Heading of the B-52 = unknown.

Heading of the top of the photo = 119.0°

Distance to the edge of the altitude hole = 1.79 nm

No echo on this photo, however, there is a “negative” blip to the rear of the B-52.

Distance of blip = 2.99 nm Direction = 312°

Orientation of the larger axis of the blip = 040 / 220°

Position of the blip on photo: x = 1437 y = 1819 (pixels)

Position of the B-52: x = 1516 y = 1434 (pixels)

Photometric levels:

- Negative Blip: 33 %; level of neighborhood = 79 %
- Echo of ground near the edge of the altitude hole = 100 %
- NB: Black = 100 % — White = 0 %

Dimension of negative blip: length = 7 pixels; width = 3 pixels, fuzzy (80 x 35 meters?).

Scale of the photo = 150 (?) pixels per nautical mile.

Appendix 3

Ground Observer Accounts of the UFO Events From the Documentation

| | | | |
|----------------------------------------------------------------------------------------------------------------------------------------------------------------------------------------------------------------------------------------------------------------------------------------------------------------------------------------------------------------------------------------------------------------------------------------------------------------------------------------------------------------------------------------------------------------------------------------------------------------------------------------------------------------|------------------------------------|---------------------------------------------------------------------|---------------------------------------------------------|
| 8. WHERE WERE YOU WHEN YOU SAW THE PHENOMENON? (Check appropriate blocks.) | | | |
| OUTDOORS | | IN BUSINESS SECTION OF CITY | |
| IN BUILDING | | IN RESIDENTIAL SECTION OF CITY | |
| <input checked="" type="checkbox"/> IN CAR | <input type="checkbox"/> AS DRIVER | <input checked="" type="checkbox"/> AS PASSENGER | <input checked="" type="checkbox"/> IN OPEN COUNTRYSIDE |
| IN BOAT | | NEAR AIRFIELD | |
| <input type="checkbox"/> IN AIRPLANE | <input type="checkbox"/> AS PILOT | <input type="checkbox"/> AS PASSENGER | FLYING OVER CITY |
| OTHER | | FLYING OVER OPEN COUNTRY | |
| | | OTHER | |
| A. IF YOU WERE IN A VEHICLE, COMPLETE THE FOLLOWING: | | | |
| WHAT DIRECTION WERE YOU MOVING? | | HOW FAST WERE YOU MOVING? | |
| <input checked="" type="checkbox"/> NORTH | <input type="checkbox"/> EAST | 35 mph. | |
| <input checked="" type="checkbox"/> SOUTH | <input type="checkbox"/> WEST | DID YOU STOP ANYTIME WHILE OBSERVING THE PHENOMENON? | |
| <input type="checkbox"/> NORTHEAST | <input type="checkbox"/> SOUTHEAST | <input checked="" type="checkbox"/> YES <input type="checkbox"/> NO | |
| <input type="checkbox"/> NORTHWEST | <input type="checkbox"/> SOUTHWEST | | |
| EXPLAIN WHETHER SUCH MOVEMENT AFFECTS YOUR SKETCHES IN ITEMS 5 AND 6. YES. OBJECT SEEMED TO BE OBSERVING US. WHEN WE STOPPED THE OBJECT SEEMED HAVEN CHANGED WHEN WE TURNED OUT OUR HEADLIGHTS | | | |
| DESCRIBE TYPE OF VEHICLE YOU WERE IN AND TYPE OF ROAD, TERRAIN OR BODY OF WATER YOU TRAVERSED DURING THE SIGHTING. STATE WHETHER WINDOWS OR CONVERTIBLE TOP WERE UP OR DOWN. 6 Pass. Truck Flat Ground, Gravel Road, windows up | | | |
| HOW MUCH OTHER TRAFFIC WAS THERE? NONE | | | |
| DID YOU NOTICE ANY AIRPLANES? <input checked="" type="checkbox"/> YES <input type="checkbox"/> NO. IF "YES," DESCRIBE WHEN THEY WERE IN SIGHT RELATIVE TO THE TIME OF SIGHTING THE PHENOMENON AND WHERE THEY WERE IN THE SKY RELATIVE TO THE POSITION OF THE PHENOMENON. A B-52 WAS SENT TO THE AREA TO CHECK OUT THE SIGHTING AND WAS SEEN WEST OF THE OBJECT AT FIRST. | | | |
| 9. HOW LONG WAS THE PHENOMENON IN SIGHT? | | | |
| LENGTH OF TIME | 1 1/2 hrs | <input type="checkbox"/> CERTAIN OF TIME | <input type="checkbox"/> NOT VERY SURE |
| | | <input checked="" type="checkbox"/> FAIRLY CERTAIN | <input type="checkbox"/> JUST A GUESS |
| HOW WAS TIME DETERMINED? WATCH (Dial) | | | |
| WAS THE PHENOMENON IN SIGHT CONTINUOUSLY? <input type="checkbox"/> YES <input checked="" type="checkbox"/> NO. IF "NO," INDICATE WHETHER THIS IS DUE TO YOUR MOVEMENT OR THE BEHAVIOR OF THE PHENOMENON, AND DESCRIBE SUCH MOVEMENT OR BEHAVIOR. INDICATE DISAPPEARANCES ON PREVIOUS SKETCHES. OBJECT MOVED SE FIRST THEN WEST, THEN SE AND OUT OF SIGHT THEN A FEW MINUTES LATER APPEARED IN THE SE AGAIN MOVING N, AT ONE TIME THE OBJECT CAME WITHIN ABOUT 1/2 MILE OF SITE THEN WAS HEADED SW THEN WENT EAST AND OUT OF SITE THEN REAPPEARED IN THE SE MOVED W THEN EAST THEN OUT OF SITE AND DID NOT REAPPEAR AGAIN AFTER THE B-52 MADE ITS FIRST PASS | | | |

Robert M. O'Connor's AF-117 (3).

A1C Robert M. O'CONNOR Field Maintenance Chief, 91st Missile Maintenance Squadron (91st MIMS), from his AF-117, dated 28 October 1968:

"I was the passenger in the 6 pack truck, on the gravel road, windows up, while traveling from N-1 to N-7, at about 35 mph. We first saw the object at 02:30 by watch (central daylight savings time) to the EAST of us while we were traveling towards the site. Our attention was drawn by the fact that there was a bigger light than the two farmyard lights, which appeared at a distance. The light just grew brighter in white light and came toward us. It started moving south. The object seemed to be observing us, when we stopped, the object seemed to hover, or stop when we turned out our headlights. We arrived at the site (N7) then started observing from outside the truck. It was moving in a large circular area to the South of us." [A drawing of the trajectory is included, which shows an oval pattern, situated in the south of N-7, with a CCW movement. The axes of the pattern are 47 and 25 mm, the largest axis being oriented East-West, and the minimum distance to N-7 being 12 mm on the drawing]. "It came within hearing distance twice, at about 15° over the horizon. The sound was that of jet engines, only more steady, and at a lower pitch. It was in this same area for two or three hours. When we last saw it, at 03:45, in the ESE, the object was in the South East and went low in the ESE and out of sight... We saw the B-52 that was sent to check out the sighting, we saw it West of the object at first... About the object movements we saw, it moved SE first, then West, then SE and out of sight, then a few minutes later, appeared in the SE again, moving North, at one time the object came within about 1/2 mile of site (N-7) then was headed SW, then went East, and out of site. Then reappeared in the SE, moved west, then east, then out of site, and did not appear again after the B-52 made its first pass. We saw it during 1.5 hours total, by watch. The object appeared self-luminous, like a big ball of white light that seemed to change to a dim green light then later to a dim amber color. The object varied to take the appearance of a sting fish... But I was unable to make out any definite shape because the object sent out such a bright light... Its apparent size seemed bigger than the tip of a match held at arm length."

Apparent size was larger than 23 minutes of arc. The moon has an apparent diameter of about 30 minutes of arc.

A1C Lloyd M. ISLEY, 91st MIMS, in his AF-117, dated 28 October 1968:

*"I saw the object from 00:30 to 04:30 central, daylight savings time. We were traveling at 30 mph south from N-1 (LCF) to N-7 (LF) in a pick up truck, on a gravel flat road, about 5 miles north of N-7. The light was first sighted in the sky at about 50° altitude angle, and when we lost sight; it was at less than 10° altitude... [drawing showing a large circular trajectory in the sky]... I observed from the vehicle then from outside, at the missile site, during 3.5 to 4 hours. During all the time we were on N-7, it went out of sight a few times and then reappeared ... A B-52 was in the same area as the object, just before the object left our view ... At one time, there were two objects, the first one in the SSE, the second one in the SSW of N-7 [drawing]... The object had lights on the front, like headlights or landing lights. It had a green flashing light towards the middle or rear. I could not tell any shape or size... **My estimate is that the object was the size of a KC-135.** I could only tell by the lights on the object, that were the same as on a jet aircraft... It went out of sight low in the South east..."*

27. INFORMATION WHICH YOU FEEL IS PERTINENT BUT WHICH IS NOT ADEQUATELY COVERED IN THIS QUESTIONNAIRE, ALTERNATIVELY PROVIDE A NARRATIVE EXPLANATION OF THE SIGHTING.

We first saw the object to the east of us while we were traveling toward the site. IT STARTED MOVING SOUTH. WE ARRIVED AT THE SITE & THEN STARTED OBSERVING THE OBJECT FROM OUTSIDE THE TRUCK. IT WAS MOVING IN A LARGE CIRCULAR AREA TO THE SOUTH OF US. IT CAME WITHIN HEARING DISTANCE TWICE. THE SOUND WAS THAT OF JET ENGINES. IT WAS IN THIS SAME AREA FOR TWO OR THREE HOURS. WHEN WE LAST SAW IT, THE OBJECT WAS IN THE SOUTH EAST AND WENT LOW AND OUT OF SIGHT.

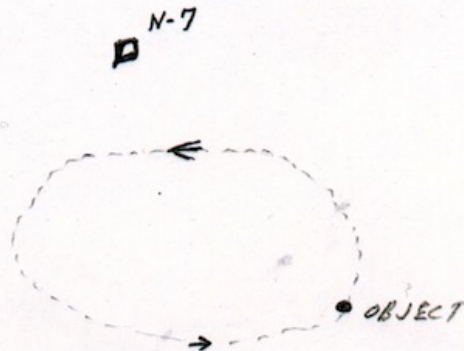

Lloyd Isley's drawing in his AF-117 (9).

A1C Joseph JABLONSKI, November-Security Alert Team member, 862nd Security Police Squadron (862nd SPS) in his AF-117, dated 25 October 1968:

“I saw the object from 03:08 to 05:18 by clock, on and off, the time was the one my team stayed out from dispatch as shown on AF form 53... I was then 9 miles south from N-1, and 2-3 miles SSE from N-7, as passenger of a 4x4 truck, with windows open occasionally, moving at about 30 mph, but we stopped to observe... The light was first seen in the sky at an angular altitude of about 35°... There was a B-52 diverted to the general area, first seen and heard approx. 35 minutes after first sighting of object. The object stayed basically to the South East while the B-52 was in the South West... The object was not in sight continuously, not due to our movement, but due to the behavior pattern of the phenomenon. The object appeared as orangish-red lighted, seem to switch to almost completely white and there was some green. This pattern was not always the same and at certain times a combination of all could be seen at once. The object first appeared to hover then move slowly, speed up, always alternating in color. Then lights would vanish, but return some minutes after... When we were first dispatched to N-7, another object, exactly the same, appeared out of the East and had picked up speed in a path moving towards the other object. I never did see the two join or meet as the second one disappeared and no longer could be seen... The object was self-luminous with glowing orange-red; white greenish alternating and at times combinations could be seen. The object appeared rather solid, although not very wide and slender in shape. Edges were fuzzy. Lights were much too bright to determine exact shape. This object appeared much brighter than a star... Other persons had brought it to my attention. Although I had not seen it immediately, they gave a good estimate of its location. When it reappeared 3 or 4 minutes later, it was quite bright and gradually weakened... Prior to return to N-1, it caught our attention again, this time WSW in location. It had appeared as before, starting bright, orange-red, to white and finally green. The object was stationary at the time and appeared approx. 1000 feet above ground. The green light started to diminish slowly till no longer seen... Just prior to our sighting of the diverted B-52 in the WSW, the object had descended gradually and for a minute or two had appeared to be obstructed by trees... Although the object appeared to be solid matter, the illumination rendered no logical shape to be determined. It had appeared quite slim and not very wide [a drawing of a long oval, 35 x 4 mm, is made by the witness]. As to the alternating illumination, particularly the white, it appeared as two or three automobile headlights. When the B-52 had flown in its search, it had been using its landing lights, which were quite similar in nature. As to avoid confusion between the plane and the object, Base Ops had pointed out where and when we saw the B-52. Must add that the B-52 engines could be easily heard while the UFO made no sounds to be heard at about the same distance... The object had various maneuvers, which occurred basically in one general area. It stayed pretty well SSE of the launch facility but at several times started Northward and Westward, always returning to its previous SSE position. For some reason, it appeared to be trying to travel west, but we never did see it take the direct path. When the B-52 flew in the vicinity (SSE) it was no longer seen in that location. When the plane had started to travel to the base, and after it was out of sight, we had also started back to N-1. Our attention was again caught when it appeared approx. 5 miles due West where it remained until it finally disappeared about 15 minutes afterwards. Offhand I'd say that close to one-half would be covered by a match head held at arm length.”

Apparent object length is about 46 arc minutes, or about 1.5 times the full moon diameter.

15. DRAW A PICTURE THAT WILL SHOW THE SHAPE OF THE PHENOMENON. INCLUDE AND LABEL ANY DETAILS THAT MIGHT HAVE APPEARED AS WINGS OR PROTRUSIONS, AND INDICATE EXHAUST OR VAPOR TRAILS. INDICATE BY AN ARROW THE DIRECTION THE PHENOMENON WAS MOVING.

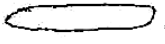
I Never could distinguish the shape because of the
Bright Light. However it seemed to be shaped as
A wainew . This is the best description
I can give, but I am not completely sure of the shape.

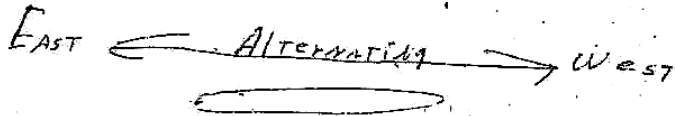

16. WHAT WAS THE ANGULAR SIZE? HOLD A MATCH AT ARM'S LENGTH IN FRONT OF A KNOWN OBJECT, SUCH AS A STREET LAMP OR THE MOON. NOTE HOW MUCH OF THE OBJECT IS COVERED BY THE HEAD OF THE MATCH. NOW IF YOU HAD BEEN ABLE TO PERFORM THIS EXPERIMENT AT THE TIME OF THE SIGHTING, ESTIMATE WHAT FRACTION OF THE PHENOMENON WOULD HAVE BEEN COVERED BY THE MATCH HEAD.

ESTIMATING $\frac{1}{3}$ would be covered by MATCH HEAD.

A1C Gregory ADAMS, November-Security Alert Team member, 862nd SPS, in his AF-117, dated 25 October 1968:

“I saw the object from 03:08 to 05:18 by clock, with O’Connor, Jablonsky, and Bond, 9 miles south from N1 and 2 miles from N7... A maintenance team working at November 7 called over radio... The object was first 30° over the horizon and later about 15°... I was driving the 4x4 truck... The B-52 bomber was heard approximately 45 minutes after seeing the UFO, the B-52 to the West, and much higher than the UFO ...Our movement had no relation with appearing and disappearing of the UFO. It seemed to assume a stationary position, at first a hovering position, then it would speed up. The reddish-orange light keep changing white and occasionally green... The lights were self luminous and very bright, size and shape hard to distinguish... I never could distinguish the shape because of the bright light. However it seemed to be shaped as a wiener [the witness drew a long oval, 19 x 3 mm]. This is the best description I can give, but I am not completely sure of the shape...Its size was compared to 8 cars with bright lights all over them... When en route to N-7, another object appeared at same distance. They seemed to get pretty close at one time, and all of a sudden, one disappeared... Right before the B-52 was seen, the UFO descended gradually behind what could have been trees, it was so dark... The last I saw of it, was when it appeared to be hovering above ground, you could see a green light for about 15 minutes, the light seem to be getting smaller until you could not see it... About its apparent angular size, I estimate that 1/3 would be covered by a match head held at arm’s length.

Apparent length of UFO was about 70 arc minutes, more than two times the diameter of the full moon.

Staff Sgt. James F. BOND, November-Flight Security Controller, 862nd SPS, in his AF-117, dated 25 October 1968:

“I saw the object from 03:08 to 05:00, from outdoor the LCF November 1, approx. 10 miles North of N-7... My attention was first called by a maintenance team at the launch facility (N-7)... The object was first at an angular height of 15° in the South West, and about at a distance of 4 miles ... My observation was not continuous because of the movement of the phenomenon... Two objects were seen for about 3 minutes, the second one disappeared when close to the first one ... The object was a light, it appeared to be self luminous, it appeared to be solid, the edges appeared to be fuzzy, it appeared then as a point of light... I lost its sight when it appeared to land and slowly changed to a dim green, after about 15 minutes it disappeared gradually... No shape could be seen and it moved in directions indicated below (large drawing with a complicated trajectory, reproduced thereafter...The object appeared about the same as landing lights in aircraft (B-52 diverted to area) except for flashing red lights on B-52. The object acted like a helicopter in flight... I have seen similar phenomena off the coast of Alaska in 1956, and Okinawa in 1965... About its size, a match head held at arm’s length would have been covered.”

Apparently, about 23 minutes of arc.

15. DRAW A PICTURE THAT WILL SHOW THE SHAPE OF THE PHENOMENON. INCLUDE AND LABEL ANY DETAILS THAT MIGHT HAVE APPEARED AS WINGS OR PROTRUSIONS, AND INDICATE EXHAUST OR VAPOR TRAILS. INDICATE BY AN ARROW THE DIRECTION THE PHENOMENON WAS MOVING.

NO SHAPE COULD BE SEEN AND IT MOVED
IN DIRECTIONS INDICATED BELOW.

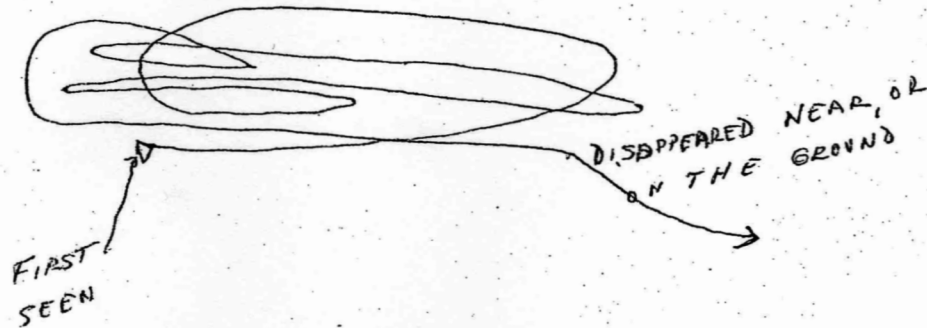

16. WHAT WAS THE ANGULAR SIZE? HOLD A MATCH AT ARM'S LENGTH IN FRONT OF A KNOWN OBJECT, SUCH AS A STREET LAMP OR THE MOON. NOTE HOW MUCH OF THE OBJECT IS COVERED BY THE HEAD OF THE MATCH. NOW IF YOU HAD BEEN ABLE TO PERFORM THIS EXPERIMENT AT THE TIME OF THE SIGHTING, ESTIMATE WHAT FRACTION OF THE PHENOMENON WOULD HAVE BEEN COVERED BY THE MATCH HEAD.

A MATCH HEAD WOULD HAVE BEEN COVERED.

Staff Sgt. William E. SMITH, Jr., Oscar-Flight Security Controller, 862nd SPS, in his AF-117, dated 26 October 1968:

“I observed the object from 02:30 to 04:15 AM from clock, central, daylight savings time, on and off during a total of 1 hour 15 minutes, from the East of Highway 83, the objects being to my South, at an angular height of about 15°... [Drawing of a zigzag trajectory in the sky]... My observation was not permanent, due to the movement of the phenomenon, which was steady, and smooth, rising slightly. It would disappear completely at times then at times would just fade or dim... The phenomenon appeared to me to be a reddish, burnt orange. I saw it fade and change as a star might twinkle. I also noticed a slight tint of green. Burnt orange, reddish was the dominant color. The object appeared as though a star would appear on the horizon a clear night (a large star). No edges were visible from my position... I was notified it had been seen in an adjacent area, I alerted my sentries. The object was first seen in the southern part of my area by a posted sentry. I directed my gaze South of my position and saw the object about 15 minutes after my sentry sighted it. It was visible one moment and just vanished! ... The object resembled the planet Mars as it is while rising on the horizon. It was similar in color and size. One difference is that it would fade (color) from view... “

Description of the UFO by B-52 Pilot Major James Partin

Major James PARTIN, 23rd Bombardment Squadron, and B-52H instructor pilot with 13 years of experience describes the UFO in his AF-117, dated 30 October 1968. He first observed the UFO ahead of the B-52, to the WNW (292°), on or near the ground while at 3200 feet MSL altitude:

“As I turned on to downwind leg in the traffic pattern [at 04:30 GMT by clock, and until 04:35], I saw a bright orange ball of light at my one o'clock position. It appeared to be about 15 miles away, and either on the ground or just slightly above the ground. The light remained stationary as we flew towards it. I turned into base leg about one mile to the South of the light and was above it. The light did not move during this time.... [My attention was attracted by] the unusually bright light I had never seen at night in this area ... [The light finally disappeared as] I turned the aircraft to position it for final landing ...It looked like a miniature sun placed on the ground, below the aircraft... [The other witness in the cockpit was] Capt. Bradford Runyon.”

Two small drawings accompany his report. The apparent angular size of the orange ball of light was 4.5 times the tip of a match held at arm length. About 103 minutes of arc, more than three times the moon diameter.

15. DRAW A PICTURE THAT WILL SHOW THE SHAPE OF THE PHENOMENON. INCLUDE AND LABEL ANY DETAILS THAT MIGHT HAVE APPEARED AS WINGS OR PROTRUSIONS, AND INDICATE EXHAUST OR VAPOR TRAILS. INDICATE BY AN ARROW THE DIRECTION THE PHENOMENON WAS MOVING.

*Orange ball
of light* →  → *A very dim ring
of soft white light.*

16. WHAT WAS THE ANGULAR SIZE? HOLD A MATCH AT ARM'S LENGTH IN FRONT OF A KNOWN OBJECT, SUCH AS A STREET LAMP OR THE MOON. NOTE HOW MUCH OF THE OBJECT IS COVERED BY THE HEAD OF THE MATCH. NOW IF YOU HAD BEEN ABLE TO PERFORM THIS EXPERIMENT AT THE TIME OF THE SIGHTING, ESTIMATE WHAT FRACTION OF THE PHENOMENON WOULD HAVE BEEN COVERED BY THE MATCH HEAD.



James Partin drawing from his AF-117 (6).

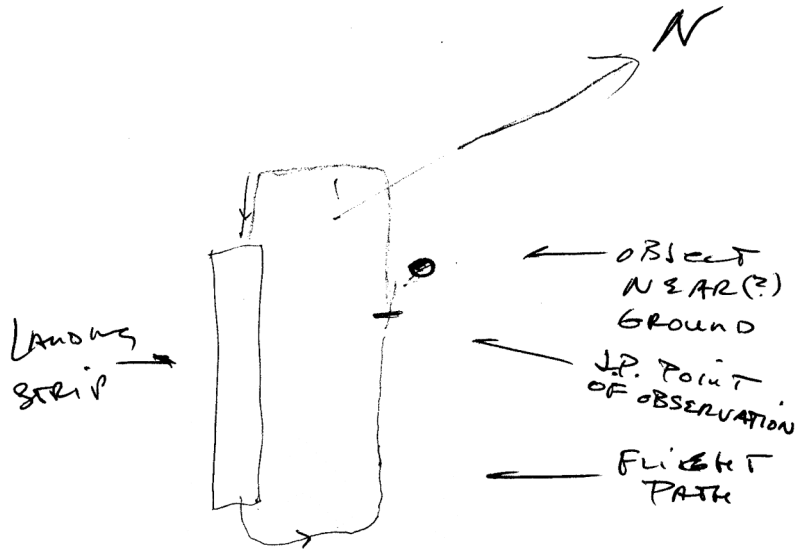

2/23/01

* 2nd APPROACH
FOLLOWING LOW
APPROACH.

PARTIAL DRAWING

Description of the UFO by B-52 Copilot Captain Bradford Runyon

Captain Bradford RUNYON, 23rd Bombardment Squadron, and B-52H instructor copilot was not interviewed during the Blue Book investigation, and did not complete an AF-117. Here is his description recorded by Thomas Tulien for the Sign Oral History Project (SOHP) on 5 May 2000, and 25 February 2005.

"Well this was during the Cold War and then we had nuclear weapons on them so we were... well we had a certain number on alert at all times, and, you know, and different times then we had 'em on alert in the air... loaded with nuclear bombs It was just a typical training mission. We take off and air re-fuel, do a high altitude navigation training for the navigators and low-level route in the...oh, just air work, and then usually come back into a few touch and go landings. But, you know, in 10 hours, we'd fly all over the United States, Canada and so on... We would have had our full crew, which would be 2 navigators and a gunner and then an electronics warfare officer... I was at 20,000 feet being the co-pilot — I handled the radios, so I requested permission to make a penetration to land and so when I did this, the controllers came back and said that they would like me to check on something if I wouldn't mind. I said, 'Well,

I've been flying for 10 hours, but if it's important I'll go check on it,' And they said, 'Well, we think it's important.', So I said, 'All right, give me a vector.', And so they pointed me in a certain direction and we started flying out through there and I got to thinking, pilot, what am I looking for? So I called and I said, 'What is it that I'm looking for?', And they said, 'Well, you'll know it if you find it.' That sort of got our curiosity up. So anyway a few minutes later my navigator said, 'Pilot', he said, 'We have something coming towards us.', He says, 'And it's... and it's coming fast.' And then the radar navigator said, it's... it's coming so fast that it... it can't avoid us and we were all ready for impact and so anyway, his voice really came up real high and you know, we thought we were going to be hit. And of course he's filming his radar scope at this time and, you know, after, well, the next day they checked his film and with the clocks and everything around the scope determined the object was coming at roughly 3,000 miles per hour and then it just stopped dead off a... a right wing or in the... off the tail... so I'm looking around trying to find it 'cause all I can see is, you know, just a haze right there and I couldn't see anything visually at that time. But then our radios went out that time and we couldn't talk to the ground or anything, so it just stayed there for a few seconds. We're just flying along, same heading we just knew it was coming fast, but he has clocks all around his scope and everything is timed and filmed and when they develop the film or check the film the next day then the bomb nav department said that was the speed... they were watching it and, you know, anyway they...they probably... you know, it wasn't going to slow down at all, then all of a sudden it just... just stopped right there... and stayed right with us at this same spot... Well, so then after — I don't know how long, but, you know, just seconds or minutes at the most, then the object on the radar scope went to the other side of the airplane and it stayed, you know, a mile, a mile and a half, something or other like that, just off the left tail of the airplane...at that position, anyway, the size of the skin paint was possibly 6 times as large as a skin paint of a tanker... So we were making straight in approach to Minot Air Force Base and so the object stayed with us, same spot essentially... our radios were out from the time the thing got close to us... and our radios never came back in until 10 miles from the runway... it set down on the ground and it was off to our left and so anyway, just a few seconds later then our radios came back in, so we continued our approach on into Minot... we proceeded on to the base and then we had a... a general officer came on the radio and told us to go back and... but, I mean, he could have been patched in from any place, so he told us to go back and fly over the... the object... we were vectored back around over the thing and actually another pattern... we were just to the outside of it, so Major Partin, you know, could look right... right down into... over the object. I was in the right seat so, you know, I had to look sort of across the airplane. Well anyway our radios went out again and I was... I was talking on the radios to the ground controllers and they said that — of course every time I radioed to an outfit, you know, we'd had a problem or something and they mentioned that our radios went dead in mid-word, not mid-sentence, but, you know, just the word broke off... There was pretty much an egg-shaped object on the ground. It was lined up with the runway, but the orange glowing part, which looked like either molten metal or lava, something like that. It wasn't shiny or glowing or anything. It... I mean it was dull... But the part that sort of made me wonder whether the thing turned around or whether or why it was pointed in the direction of us, then there was a shiny tubular section that came from the end away from the runway. So it's the part that I thought was the control center. So anyway, it was smooth metallic looking, round tunnel. It attached to sort of a crescent moon-shaped object which sort of wrapped around the one end of the larger mass and it was smooth, shiny, metallic-looking... Where the object was curved on the back end, or the front end — whichever it was, the metallic part had the same

curvature and it was the same width as the rest of it, but it just wasn't very long. Yeah, I tried looking in there, but I... I couldn't... I could see, you know, some lights, and it seems to me like I can remember a brilliant yellow, but I... I just, you know. There were lights and I thought I should be able to see objects in there. You know, we went over real fast and... and I really couldn't distinguish anything inside.... We went back at about 150, 200 mph, so, you know, and that would've been probably 1,000 feet of it. But, you know, you can see objects on the ground real... real well. It was real clear there on the ground... the controllers were asking me if we had it and so forth. I'm talking to them. And then so after we went back and turned towards the runway again then the radios came back in. Of course they had me change and trying different frequencies and everything, but there wasn't anything wrong with the radios. We had finished our observation and went in and landed and Major Partin went in for the UFO debriefing... after everyone had been debriefed, the Air Force officials came in that night or the next then we were briefed on what had gone on. So that's when we were told, you know, what started it...while we're out flying around, then oh, an alarm goes off in one of the missile silos and anyway, uh...turns out that — this is what was told to us at the briefing by a general officer the following day. So air police were dispatched to check on the missile alarm and so the first air policemen that were sent out didn't check in when they should have so they sent others to check on 'em and the second group found the first group unconscious around their vehicle with the paint burned off the top of the vehicle, and when they came to they... they said that, you know, something... some object had... they thought it was going to sit down on top of 'em and so they started running. That's the last that they knew, but...it didn't squash their vehicle or anything so it didn't sit down on them. And so... but anyway it turns out that the reason that the alarms were set off was the 20 ton concrete lid covering the top of the missile silo had been removed and a chain link fence around the thing had been squashed and there was radioactivity around and the inner alarm down the side of the silo had also been activated. Well, it turns out that there were two ways to remove the concrete lid. You either have a large crane that'd lift 20 tons and set it off to the side, or have explosive charges that blow it off in case one launched a missile to go to war. Explosive charges hadn't been activated... this was just told to us. Now that's why it was such of an important nature to the Air Force, because of the missile they had checked out... well, I'm sure they didn't tell everyone. They just, you know, told people with top-secret security clearances and it was just such a matter of importance. That involves national security when ever, you know, have your nuclear missiles tampered with... [Interviewer: Do you think there's anyway that they could've vectored you on the object without radar?] BR: No...no...not with the precision that they did it. No... no one interviewed me, period. Just Major Partin was only... only one that, you know, from our crew was interviewed at all... We were afraid to say anything... I had a pretty good military career. I didn't want to jeopardize that....I don't know anything about plasma, but ball of anything just can't stop like it did and, you know, do the things that this thing did.... And the object we saw on the ground, you know, it... it wasn't... well, it was different types of material. It wasn't all... it wasn't just a big ball of... of glowing anything. It was... it had different features to it... on the main body part. It was just that orangish color. The part, you know, I thought was the... the cabin, the control center...it had colors inside it. I mean, the colors I saw really weren't on the outside. I looked in... inside. They were, you know, back inside. ...About 4 years ago when I was taking a... a state test for a state job, there was someone in the group taking a test with me about my age, so I just asked him where he was from or something. Anyway, it turned out that he and I both went to high school at Pikeville High School and he was 2 years behind me and there...discussion about where we went after school. I told

him I was stationed in the Air Force, Minot Air Force Base in North Dakota, and he just mentioned that he had been up there too and so I asked if he was in the Air Force also, and he said, 'No.' He said that he was in the CIA, and I said, 'Well what was the CIA doing up at Minot?' He said 'Well, they sent me up there to investigate an incident between a B-52 and a UFO.' And so I told him, 'Well, I was flying the B-52.' So we discussed that a little bit and I mentioned that Project Blue Book had said that there was just a ball of lightning and it wasn't a UFO and he just made this statement, says, 'They lied. It was a UFO.'"

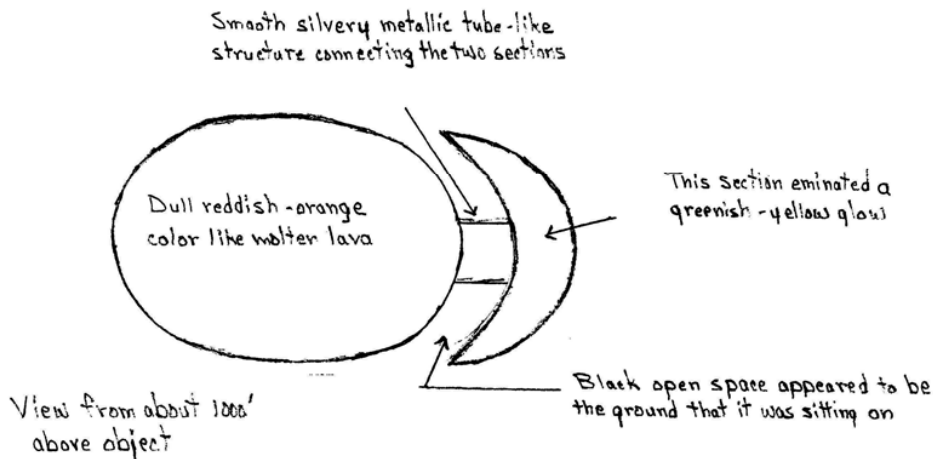
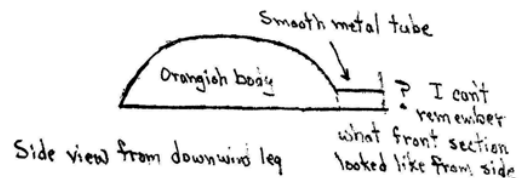
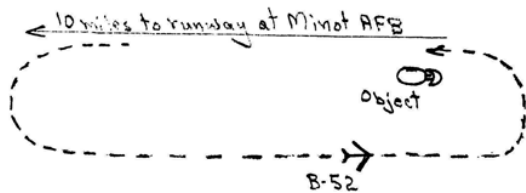

* Drawing by BRADFORD
RUNYON. 11/28/00 (TAT)

Now, from Runyon's SOHP interview on 25 February 2005:

"Most of our approaches begin at 20,000 feet. So I'm sure I requested clearance to 20,000 or Flight Level 200, which... at 18,000 feet then you reset your altimeter to two-niner-niner-two (29.92) for above 18,000 feet, everyone is flying with the same altimeter setting so it keeps your distances... one of the controllers just came over and said: "while your flying... we would like for you to check on something out... in this certain area... I asked, "What are we looking for? And they said, "well you will know it if you see it," ...and then after that someone mentioned that maintenance people have been seeing UFOs ... Anyway, we are just flying out towards the TACAN penetration point, so the ground controllers told me that I had, for me to look out at my 1:00 position, that I should have something out there and I couldn't see anything... Shortly thereafter, the Navigator told me that we had something at right off our wing, at 3 o'clock... and of course I am looking there too, and I really can't see it... we reached our penetration point and

our radios had quit working when the object got in close to us. I'm not sure just at what point I realized that we couldn't talk to the ground... but we made our turn and penetration back towards the base and departed our altitude without receiving permission which it bothered me at the time...because it was basically illegal to change your altitude without approval beforehand... sometime maybe during the turn or later after we headed back in, then the Navigator mentions that the object has moved over to the other side of the airplane and ... I don't know if it was then when it came in real fast or the first time... then it came in real fast. I know that Pat McCaslin said that it was... I felt the thing was closing too fast to stop...At first they just told us if we could read them to squawk Ident... so, you know, the aircraft commander just hits a button and we already had a certain code set in...so it just flashes on their radar... but we still couldn't talk to them and so they just said if we were having an emergency or having any serious problems then to squawk another code and we didn't, so they figured we were all right... we were headed out away from the base to this TACAN penetration point... I don't know how far out that penetration fix was but I thought it was 35 miles out from the base... and then the navigator had it there, and it just stayed with us for, well say ten miles anyway... at one point the navigator called and said it's set down on the ground, he, I don't think he said it had left us, but... it had, it had left... but he was, he was pretty sure it had, that it had set, it had gone down and set on the ground... it was with us from there until 10 miles from the base...Then our radios came back in and just as soon as the Navigator told me that he no longer had it, that it had dropped off his radar and... then I, I checked in with the Approach Control and told them that, basically that their UFO wasn't with us anymore.. . And that our radios were working and they told me to try another frequency or two and we tried that and we stayed on their best frequency... as we were making the approach I think that we had in mind to land because we were sort of fatigued...But we received instructions over one of the radios and it said that such-and-such general wanted us to fly back out and over fly over the object and see what we could see about it... the ground controllers knew that, they could hear, or, well I don't know if they could hear but they knew, that we were supposed to go back and over fly the thing, they gave us a heading to fly back over the object... and when we made our go-around over the runway, made our turn, and headed back, and as soon as we rolled out at wings level, there was an orange glow sitting out there... almost off our nose about 11:30 position, just a little bit to the left side of the airplane so we were heading towards it... I got busy with checklists and fuels... and things like that... You have 36 different fuel switches, I remember and you can take fuel out of certain tanks to a certain point. You just don't run those tanks dry you... have to take them out of others, so you have two pages of checklist just on fuel settings... you have to do it in sequence to keep the airplane balanced... and so, but there are other checklists I would have to run too and... just various things I would have to do and, by that time I was caught up, you know, and Major Partin was flying the airplane...And you know, just as soon as I got everything caught up, I looked up and we were on top of it... I think the speed was 180 indicated so it's roughly 200 miles per hour... so at 200 miles per hour it doesn't take you long to go 10 miles... when I first looked up, we were already beside it... and so I didn't look straight ahead out my window, but maybe from the corner from my eye I could tell that it was to the other side but... anyway, I, when I looked up, I looked out the pilot's window, or possibly the side window... so I just looked up and there was something there that to me... well the first thing I saw was a dark square, a rectangle... and then this red, a dull red around it... I mean, it wasn't well lit it would blend in with the ground pretty well... or the night sky, but this one part, one shadow was completely black... and my eyes were drawn to it and I was thinking, 'well that's a barn, loft and the door's open where they put hay in the thing... but I was thinking that a barn

wasn't going to be that high, 'cause I'm really not looking down, I'm looking out, maybe down some... to the side... so my concentration was on that... dark spot for, at first... well so we're flying beside the object and I take my eye away from that, you know, I just sort of glanced, there was really nothing to see, just this dull reddish, and I didn't see the bottom, and I didn't see the top, I'm just, may be I'm not looking, I'm just looking along the side... and might be for my field of view was limited looking across the airplane also... so then we come to a metallic cylinder, sort of like stainless steel or shiny aluminum or something like that... it's protruding from the end of this thing and it's on the ground and the ground is just well-lighted here. I could see maybe trees, bushes or breaks in the ground, I could see different... things on the ground... well lit, and so as we are going past this, I looked back and I thought that this thing might be pretty close to the first big part of the object, but it appeared to be attached and it was coming out of the end of it, and that end was well lit and it was sort of barn red, but it was lighter, it was a whole lot brighter than it was down the sides, basically I figure from the glow from the next section which was... sort of like a crescent moon, but it was a crescent shaped object... and it was attached to the other end of the cylinder... and the light illuminating from it had the cylinder completely illuminated... just about as if it was daylight really... and the crescent shaped part appeared to be solid but it appeared to be almost translucent like you could almost see through it, but it didn't have anything... wavy or anything, it was, it was solid, the lines were... distinct on it... and it was as high or higher, it was higher than the tube section was... but not a whole lot higher... and it wasn't nearly as high as the main body of the thing was... and as we banked over it, to make our crosswind, I guess we were told to turn about that time and our radios went out again because I did transmit something... and they didn't receive, and so as we went by it, it was pretty good size also because, that is all that really showed up, or maybe I was just concentrating on it and didn't see anything else... but at one point I could see it and the tubular section and the front part of the main body together, but it took us several seconds to go around the thing, to make our turn... it was probably in view... I, I don't know, well, several seconds anyway... I would probably put ten seconds in the range... because, you know, we flew down the side of it for about two or three, maybe four seconds... we are just level... and we don't bank until we get right to the end of it... Major Partin started his turn just as we got right to the end of it and turned almost over the top of the thing... and then we were... I'm sure we were told to turn by the ground controllers so they knew exactly where we were in relation to it... before we left we were notified to be at a certain place uh... later that morning... for debriefing... or some time during the day, but it was already morning and it seemed to me like it was just a few hours before we met... it was small office and it was plenty for the few of us who were there.... It wasn't a great big place or anything... Well basically instead of asking us any questions he just informed us as to what had gone on... during that night, and he had mentioned about outer and inner alarms going off at one of the missile sites and one thing that he did mention that there had been two different instances having to do with missiles within a week... so he did mention that there had been outer and inner alarms activated... air police had been sent to investigate, the first air police hadn't reported in when they were suppose to, the other air police were sent to check and they found the first air police either unconscious or coming, regaining consciousness, and the paint was burned off the top of the vehicle that they were in... they had told the other guys that the last they remembered is that something was starting to sit down on them... and they started running and that was the last thing they remembered and then the general officer told us that the Air police did go onto the missile site and the 20 ton concrete blast door... I don't know, he might have called it blast door, anyway, that 20 ton concrete lid or door had been moved from the top of one of our Minuteman

Two missiles... and that the inner alarm down the inside the thing had been activated... and he also mentioned that Air Police had seen us fly over, and they had seen the object that was on the ground there... take off and fly up and join up with us... and basically, that was it...I was never contacted by anybody... about anything... at first I was apprehensive when I thought the thing was going to hit us... but after that, I wasn't really that much concerned about it... we went out and flew out over the thing, 'course, you know, I was sort of concerned that, you know, it might interfere with something on the airplane... power, electronics, or something like that, but really my biggest concern was just the air, or, you know, the airplane itself being affected... I guess, you know, that it was during the debriefing that the general mentioned that the radar had picked that up, maybe the weather radar.